

# SCU5: Controller

---

Product and User Manual

Firmware Version 3.6

## Copyright Information

*All of the information herein is the exclusive proprietary property of Roll-2-Roll Technologies LLC, and is disclosed with the understanding that it will be retained in confidence and will neither be duplicated or copied in whole or in part nor be used for any purpose other than for which it is disclosed.*

*Information in this document is believed to be reliable and accurate. However no responsibility is assumed as a result of its use nor for any inaccuracies, infringement of patent or other rights of third parties resulting from its use.*

*The information in this document is subject to change without any notice.*

# CONTENTS

<b>INTRODUCTION</b>	<b>2</b>
Web Guiding Application	2
Web Position Sensor	3
Web Guide Controller	3
Guide Mechanism	4
Measurement and Sensing Application	4
Sensor and Web Guide Controller Specification	5
Controller Options	6
Physical Dimensions of SCU5	7
Power Input (Port 1)	7
Switchcraft DC Connector	7
Industrial DIN Rail Power Supply	7
Grounding	7
Sensor Interface	7
Motor Communication (Port 2)	8
Analog Output (Port 2)	10
Industrial Ethernet Interface (Port 3)	10
Opto-Isolated Output (Port 3)	10
<b>SAFETY INSTRUCTIONS</b>	<b>11</b>
Instructions for Use	11
Proper Use	11
Improper Use	11
Static Discharges and Grounding	11
<b>OPERATION AND OPERATOR INTERFACE</b>	<b>12</b>
Main Operator Interface Screen	12
Heartbeat Indicator	13
Web Detected Indicator	13
Web Position Indicator	14
Sensor Orientation Indicator	14
Find Edge Button	15
Automatically find the sensor orientation	15
Enable and disable the sensors	16
Automatic/Manual Icon	16
Servo Center Icon	17
Jog-left/Jog-right Icon	17
Guide Point	18
Guide Point Indicator	19
Guide Point Offset	19

Guide Point Adjustment	19
Fine Guide Point Adjustment	19
Gross Guide Point Adjustment	19
Reset Guide Point	20
Actuator Position Bar	20
Advanced Settings Menu	21
Operator Settings Screen	21
Operator Sensor Screen	22
Sensor Mode	22
Thresholding Mode	22
Sensor Selection	22
Minimum Contrast Gauge	22
Brightness Gauge	24
Brightness Control	24
Live Processed Image Preview	25
Selected Feature	25
Feature Navigation	27
Teaching	27
Contrast Mode	27
Right edge of a color	27
Edge created by two colors	28
Color of a line	28
Left Edge of a color	29
Operator Width Screen	30
Nominal Width	30
Upper Limit	31
Lower Limit	31
Measured Width	32
One Sensor	32
Two Sensors	32
Teaching	33
Output Type	33
Absolute	33
Error	33
Display Screen	34
Power User Screen	34
Actuator Setting	34
Stroke	34
Pitch	35
Motor Polarity	35
Servo Center Polarity	36



Speed	36
Acceleration	36
Sensor Setting	36
Automatic Brightness Control	36
Brightness Value	37
Enable/Disable Sensor	37
Sensor Position/Orientation Setting	37
Controller Setting	38
Gain	38
Deadband	38
Reverse Error Polarity	39
Lock on Lost Edge	39
Servo Center	39
Limit Switches	40
Master Slave	40
Analog Output Setting	41
Output range selection	41
Analog mode	41
Analog setup	41
Password Setting	42
Communication Setting	42
Ethernet	42
DHCP	42
FTP	42
IP	43
Subnet Mask and Gateway	43
MAC address	43
Module Type	43
Network IC Type	44
<b>REMOTE CONTROL AND MONITORING</b>	<b>44</b>
EtherNet/IP Connection Parameters	44
PROFINET Connection Parameters	45
EtherCAT Connection Parameters	45
Controller Output and PLC Input	45
Sensor status and fault registers	46
Sensor 1/Sensor 2 Left Edge	47
Sensor 1/Sensor 2 Right Edge or Contrast	47
Sensor 1/Sensor 2 Coverage	48
Quality Factor Registers	49
Web guide status and fault registers	50
Guide point percentage	51

Actuator speed percentage	51
Actuator acceleration percentage	51
Sensor 1 Thread Count	51
Sensor 2 Thread Count	51
Sensor 1 /Sensor 2 Web Width	51
Controller Input and PLC Output	52
Sensor Command Register	53
Sensor Brightness Command Register	55
Remote Light Control (RLC)	55
Remote Brightness Limit (RBL)	56
Maximum and Minimum Brightness Limit	56
Sensor 1/Sensor 2 Automatic Brightness Control (S1A and S2A)	56
Sensor 1/Sensor 2 Brightness Override (S1BO and S2BO)	56
Sensor 1/Sensor 2 Brightness Override Value	56
Web guide command register	0
Guide point offset register	59
Actuator speed register	59
Actuator acceleration register	59
<b>COMMISSIONING</b>	<b>59</b>
Sensing and Measurement Application	59
Web Guiding Application	60
Edge Guiding	60
Center Guiding Application	61
General Maintenance	62
<b>TECHNICAL SUPPORT AND SERVICE</b>	<b>62</b>
Contact information	62
Return shipping instructions	62
<b>REVISION HISTORY</b>	<b>63</b>
Hardware Revision	63
Firmware Revision	63

# INTRODUCTION

This product manual provides information about installation, use and maintenance of SCU5 controller. The controller includes an operator interface that is used for both measurement and control applications within converting lines. For installation of the sensor and web guide please refer to the respective product manuals.

The controller is designed for use in indoor industrial and laboratory equipment that process materials in web form as they move through a converting or raw material manufacturing process.

The controller can be used in closed loop control applications such as web guiding applications for edge, contrast and center guiding. The controller can also be used for other standalone sensing applications such as width measurement, thread counting, mark detection, contrast position measurement, gap detection and the like.

## Web Guiding Application

A web guiding system is a fully automatic mechatronic system used to accurately align/steer web materials within roll-to-roll machines. The web guide is used at critical locations where accurate alignment of web is necessary. Typical locations include at the unwind section, before process sections, such as before printing, coating, laminating, slitting, and rewind section. Accurate web guiding will improve productivity by enabling high speed transport and manufacturing.

There are three main components to a web guiding system:

1. Web position sensor
2. Web Guide Controller
3. Guide mechanism



*Fig. 1: Components of a web guiding system*

## Web Position Sensor

The web position sensor provides the vision for the control system. The sensor captures the image of the web position (edge or a contrasting feature on the web) and sends that information to the controller for further processing.

## Web Guide Controller

The controller is the brain for the control system. Based on the image captured by the sensor controller processes the image and determines the corrective action necessary to accurately align the web material. The web guide controller encloses the electronic hardware for the sensor processing, operator interface and the control algorithm for the web guide/actuator.

## Guide Mechanism

The web guide mechanism is the muscle for the control system. The guide mechanism actuated by a motor physically steers the web to the required position based on the command from the controller.

## Measurement and Sensing Application

The controller along with an appropriate sensor head can be used for standalone sensing applications such as edge detection, contrast position detection, width measurement, web centerline position measurement, thread counting, gap detection, etc. The sensor and the controller perform the same functions, however further processing is carried out by the controller to provide higher level measurement information.

## Sensor and Web Guide Controller Specification

The general specifications of the SCU5 controller are listed below. Depending on the application one of more of the output options would be available.

<b>Operator Interface</b>	Color touchscreen	<b>Output (Voltage)</b>	± 10 V or 0 to 10 V
<b>Languages</b>	Language independent	<b>Output (Current)</b>	0 to 20 mA or 0 to 10 mA
<b>Motor Driver</b>	Microstepping or servo drive	<b>Connectivity</b>	EtherNet/IP, PROFINET
<b>Motor</b>	Servo or Linear hybrid stepper	<b>Input Supply</b>	24 V DC
<b>Controller Frequency</b>	50 to 200 Hz	<b>Current</b>	5 A

The most basic controller is the SCU5 D which has the operator interface integrated within the controller. The controller is used for standalone measurement and sensing applications. Analog output of the sensor measurement is provided so that the controller can be connected to legacy systems (legacy web guide controllers, servo valves, pneumatic valves, etc.) for closed loop control. The analog output can also be connected to a PLC for measurement monitoring application. Advanced measurement and sensing applications can utilize either the EtherNet/IP or PROFINET industrial Ethernet connectivity option.

For a web guide controller, the analog output option is replaced with an RS485 communication option to drive a web guide actuator driver manufactured by Roll-2-Roll Technologies LLC.

## Controller Options

Following table shows the capabilities of the different controller option

Options	SCU5 D	SCU5 C <sup>4</sup> (X)D	SCU5 MD	SCU5 MC <sup>4</sup> (X)D
Input	24 VDC	24 VDC	24 VDC	24 VDC
Application	Sensing	Sensing	Web Guiding	Web Guiding
Analog output	YES	YES	NO	NO
Voltage output options	± 10 V <sup>2</sup>	± 10 V <sup>2</sup>	NONE	NONE
Current output	0 to 20 mA <sup>3</sup>	0 to 20 mA <sup>3</sup>	NONE	NONE
Motor Controller			YES	YES
Current Consumption	< 2.5 Amps	< 3 Amps	< 5 Amps	< 5 Amps
Controller Frequency	50 - 200 Hz	50 - 200 Hz	50 Hz	50 Hz
Industrial Ethernet		YES		YES
Web browser dashboard		YES		YES
Remote Control		YES		YES
Diagnostics/Fault Info		YES		YES
Process two sensors	YES	YES	YES	YES
GO/NO GO	YES <sup>1</sup>	NO	YES <sup>1</sup>	NO
Standalone System	YES	YES <sup>5</sup>	YES	YES <sup>5</sup>

<sup>1</sup> Two digital 24 V NPN GO/NO GO output are available upon request. This is not a standard.

<sup>2</sup> can be programmed to be ± 10 V or 0 to 10 V or ± 5 V or 0 to 5 V based on application requirement

<sup>3</sup> can be programmed to be 0 to 20 mA or 4 to 24 mA or 0 to 10 mA based on application requirements.

<sup>4</sup> the industrial ethernet has two options C(E) for EtherNet/IP and C(P) for PROFINET

<sup>5</sup> can be made standalone when not connected to a remote controller (PLC) or when set by remote controller (PLC)

## Physical Dimensions of SCU5

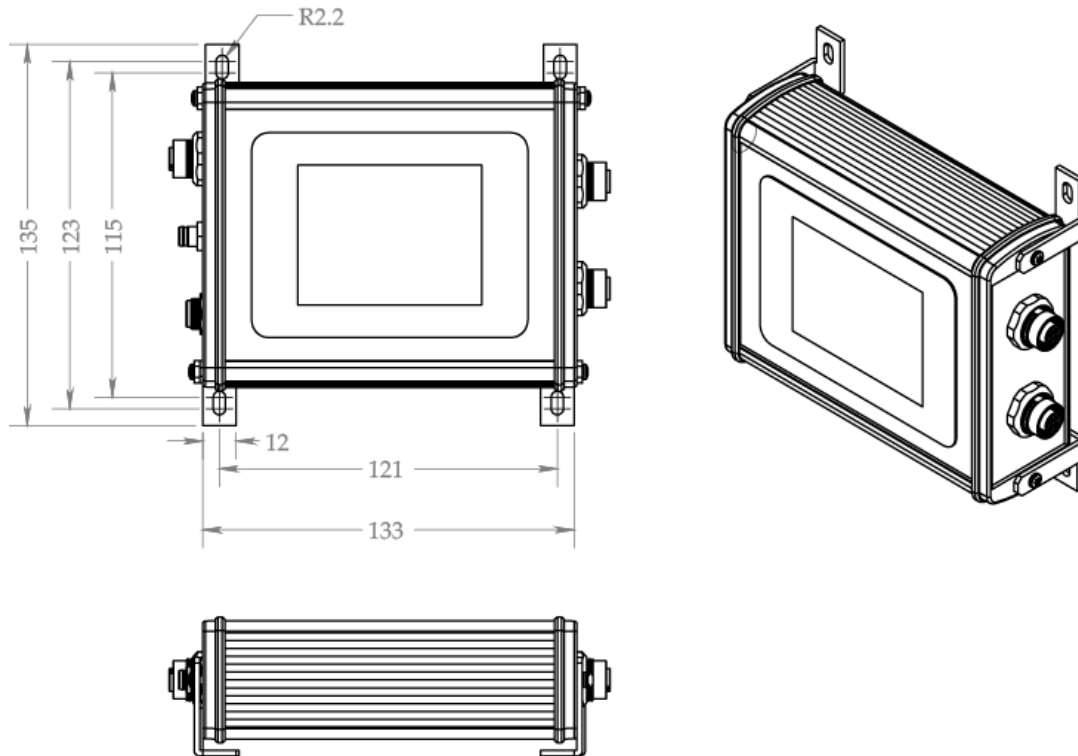

Fig. 2: SCU5 M Controller Physical Dimensions (All dimensions are in mm); Subject to change without notice.

The SCU5 M controller has the following ports for connections to the sensor, motor driver and other devices.

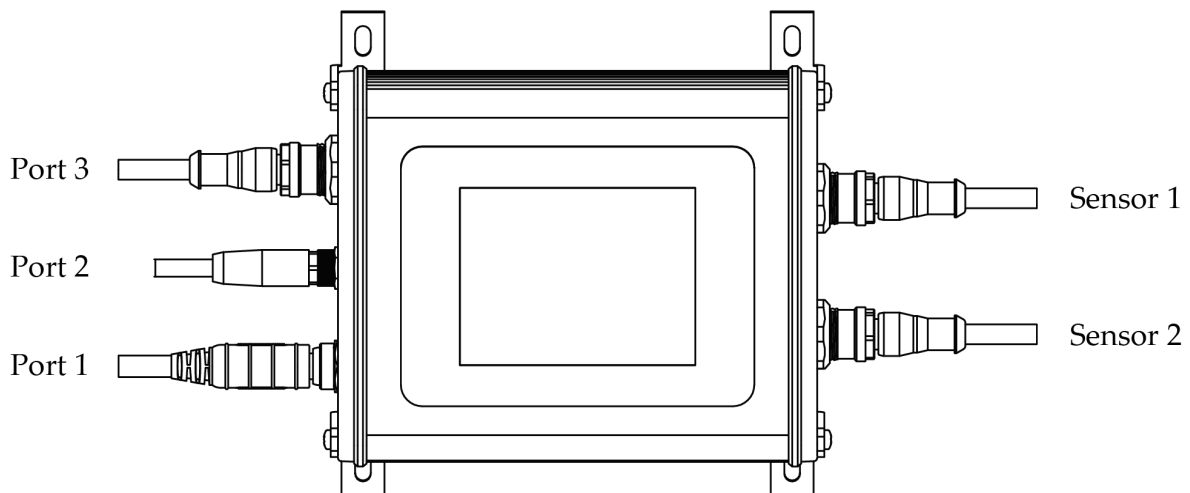

Fig. 3: SCU5 MD Connector Ports

## Power Input (Port 1)

The SCU5 M operates under 24 VDC ( $\pm 5\%$ ) power with a maximum current requirement of 5 Amps. The power is supplied through a Switchcraft DC power connector.

**WARNING:** Supplying more than 24 VDC would damage the controller permanently.

**WARNING:** A reverse polarity connection may also damage the controller permanently.

### Switchcraft DC Connector

Sealed [Switchcraft L712AS](#) power jack port option is available on the SCU5. A mating [Switchcraft 761KS12](#) plug connector or a pre-assembled [Switchcraft CARA761KS07984](#) or a pre-assembled [Switchcraft CA761KS07984](#) can be used to supply power. For the plug connector the 24 VDC power should be supplied to the tip/center pin and electronic ground on the sleeve pin. For the pre made cable assembly from Roll-2-Roll the 24 VDC should be connected to the red cable and the electronic ground connected to the black cable.

Pin	Signal
Center Pin	+24 V
Sleeve	GND

### Industrial DIN Rail Power Supply

Industrial DIN rail mountable power supply such as [Mean Well SDR-75-24](#) can be used to supply 24VDC power. This is an available purchase option.

### Grounding

For safety and for normal operation, the SCU5 M controller, the equipment to which the controller is installed must be properly grounded. The metal enclosure surface or the mounting screws may be used to properly ground the controller to the protective earth.

**WARNING:** Please use all possible options to safely earth ground the controller. Improper grounding may result in static buildup that can potentially result in malfunction of the controller.

### Sensor Interface

Two sensor ports labeled Sensor 1 and Sensor 2 have industry standard 12-pin M12 connectors to connect the 12-pin connector on the sensor cable. Either sensor ports can be used to connect the sensor(s) and the controller will automatically recognize the connection.

**WARNING:** The connectors are keyed and please DO NOT force the connectors. Forcing the connector may damage the pins and eventually can damage the sensor and or the controller.

**NOTE:** If two sensors are connected and configured for edge mode, the controller will automatically configure the appropriate guiding method based on the orientation of the edges. If both the left and the right edge is seen by the sensor, the center guiding mode will be enabled. If both the sensors see the same edge of the web then an average of the sensor measurement will be used to guide the web.

**NOTE:** If two sensors are connected and configured for contrast mode, only the sensor that is selected will be used for guiding.

**NOTE:** The sensors can be enabled or disabled electronically within the controller even if they are physically connected with cables.

**NOTE:** If two sensors are connected and configured for edge mode, the analog output can be configured for left edge, right edge, centerline web position or web width.

**NOTE:** If two sensors are connected and configured for contrast mode, the analog output can be configured for left edge, right edge, centerline web position or web width.

**WARNING:** Only the sensors and cables provided by Roll-2-Roll Technologies LLC should be connected to the sensor ports. Third-party cables and sensors may damage the controller and will void the warranty. Please consult with the factory before adding any patch cords.

## Motor Communication (Port 2)

The SCU5 controller with “M” suffix includes a 4-pin Male M8 connector to connect the controller to a motor driver (supplied by Roll-2-Roll Technologies LLC) used for web guiding applications. A pre-wired motor communication cable with the 4-pin M8 female connectors on both ends is used to connect the controller and the motor driver. The motor communication cable carries the power and the communication signals between the SCU5 M controller and the motor driver.

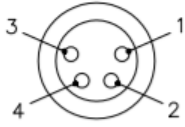
 1 = BROWN 2 = WHITE 3 = BLUE 4 = BLACK	Pin	Color	Signal
	1	Brown	+24 V
	2	White	RS 485 B-
	3	Blue	RS 485 A+
	4	Black	GND

**WARNING:** Never connect or disconnect the motor communication cable while the SCU5 controller is powered or connected to a power supply. Always power down the SCU5 controller during the connection/disconnection of the motor communication cable.

**WARNING:** Only the cables provided by Roll-2-Roll Technologies LLC should be connected to the motor communication port. Third-party cables and sensors may damage the controller and will void the warranty.



## Analog Output (Port 2)

The SCU5 controller without the motor suffix will include a 3-pin Male M8 connector for analog output. The pinouts for the connector are shown below.

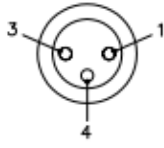
 <p>1 = BROWN 3 = BLUE 4 = BLACK</p>	Pin	Color	Signal
	1	Brown	Voltage
	3	Blue	Current
	4	Black	Ground/Common

The outputs can be chosen via the touchscreen interface to any of the following available output options:

Voltage	Current
0 - 5 V, 0 - 10 V, $\pm$ 5 V, $\pm$ 10 V	4 - 20 mA, 0 - 20 mA, 0 - 24 mA

**WARNING:** These pins are isolated outputs. Do not connect a power source to these pins. Some analog input cards on PLC might have a voltage source to power sensors. Please do not connect the voltage source to these pins. This might permanently damage the controller.

## Industrial Ethernet Interface (Port 3)

An optional industrial ethernet connection is available on models with suffix C(E) or C(P). A 4-pin D-coded M12 socket connect is provided for ethernet connection. Standard network cables such as Phoenix Contact [NBC-MSD/ 1.0-93E/R4AC SCO - 1407360](#) or [VS-MSD-IP20-93E/5.0 - 1403500](#) can be used to connect the SCU5 M to an ethernet network using RJ45 plug.

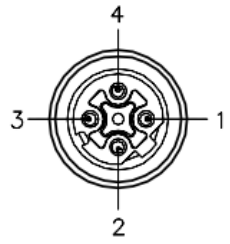
	Pin	Color	Signal
	1	White/Orange	+TX
	2	White/Green	+RX
	3	Orange	-TX
	4	Green	-RX

## Opto-Isolated Output (Port 3)

For some applications two opto-isolated outputs are available from the SCU5 controller. These outputs are available on a 4-pin M12 female pin connector. A standard M12 4-pin A coded male connector or a pre-wired M12 cable can be used for the connection. The pin functions for the connector are shown in the table below.

Pin	Color	Signal
1	Brown	VDD
2	White	OUT2
3	Blue	GND
4	Black	OUT1

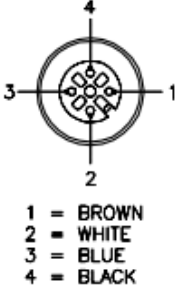

The outputs can be used as NPN output by providing a VDD (5 - 24 VDC) and GND from a PLC and the signal through the two outputs OUT1 and OUT2. Custom programming can be done to provide a GO/NO GO type of output or a digital ON/OFF signal.

### NPN Normally Closed Output

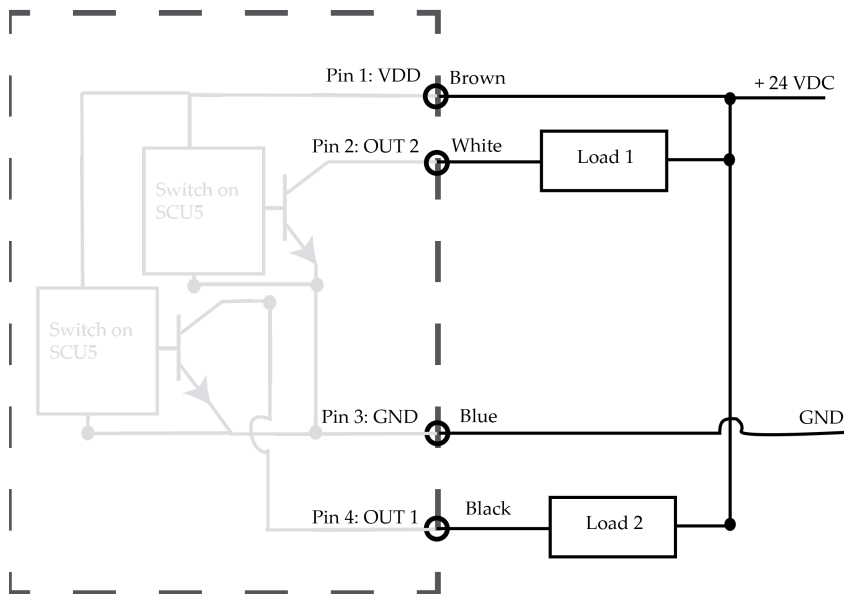

When the respective output signal is enabled then that signal would go low. And normally the signal would be high if wired as shown in the schematic on the left. Note that the outputs are normally closed. If wiring a relay, wire to the NC side of the circuit so that the appropriate output from the relay is provided to the device.

# SAFETY INSTRUCTIONS

The SCU5 controller is an electronic device that operates on low voltage (24 V DC). However, it does present a few safety requirements that must be followed in order to assure safe and effective operation of the system.

## Instructions for Use

The SCU5 controller must be properly transported, stored before being installed professionally. The controller should not be installed or commissioned for operation if any visible damage is observed. Only persons who have the necessary qualifications should work on the installation, commissioning, operation, and maintenance of the system.

Notes:

- Please read the product manual and properly follow its instructions
- Please read and follow the warning labels on the device
- Be aware of all national, state, and local requirements for accident prevention and environmental protection.

## Proper Use

The SCU5 M controller is intended for indoor use only for use in industrial and lab equipment that process materials in web form as they move through a converting or raw material manufacturing process.

## Improper Use

- Outdoor use or exposure to direct sunlight is considered improper.
- Any use outside the general specifications shall be considered improper use and voids any warranty of the equipment.
- Any replacement parts or modification necessities should be made by Roll-2-Roll Technologies LLC.

## Static Discharges and Grounding

- Web, especially plastic webs, when transported over rollers can create significant static voltage potential. This static may discharge to the controller through the sensor cables. The static potential needs to be safely discharged by proper grounding of the controller.
- Ensure that the sensor, the controller and all other devices connected to the SCU5 controller are properly grounded as well.
- Proper grounding can be ensured by checking for the continuity from any of the connectors on the controller and the earth ground.

# OPERATION AND OPERATOR INTERFACE

## Main Operator Interface Screen

The main operator screen provides relevant information and operator access for both the sensing and guiding application. The web guiding operations are accomplished using the web guide operation buttons on the bottom of the screen.

The capacitive touchscreen on the SCU5 controller uses a language independent icon based screen that allows ease of operation.

Never use sharp or pointed tools of any kind to operate the interface. Best practice is to have operators use their fingers to press the different icons. Care must be taken to clean the touch screen surface periodically.

Its icon based design allows for a language independent operation without the need of translation of the screen for setup and operation in different countries.

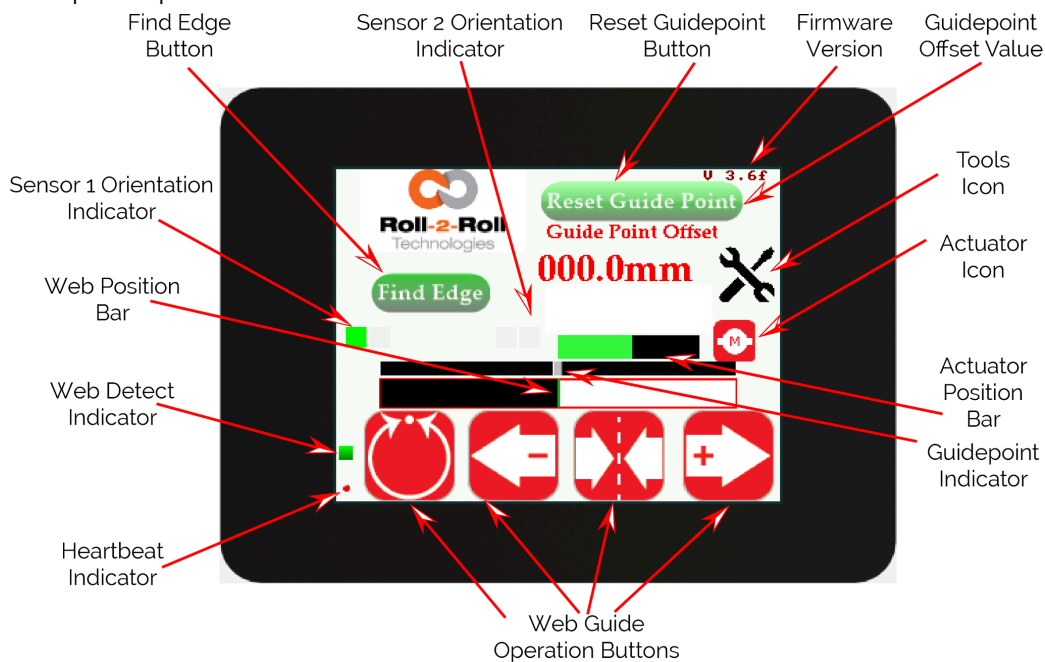

## Heartbeat Indicator

A round indicator at the bottom left of the operator interface indicates the heartbeat or the communication between the electronic controller board and the operator interface.

- This indicator is used for troubleshooting purposes.
- During normal operation this indicator will toggle between red and green at about 1 Hz.

**NOTE:** Slow heartbeat may indicate communication delay between the main motherboard and the touchscreen display/operator interface.

## Web Detected Indicator

A small square indicator on the bottom left part of the screen indicates the presence and absence of the web as seen by the sensor in the respective mode of operation. When in edge mode the indicator turns green whenever the sensor sees a web edge. When in contrast mode the indicator turns green when the desired contrast is seen by the sensor.

This web detect indicator can be used for troubleshooting purposes. If this indicator turns off intermittently while a web is in front of the sensor it may indicate that the sensor is finding it difficult to accurately sense the web edge or the contrasting feature. This indicates a low contrast condition. Such a condition may occur for optical grade clear webs with low scattering in the infrared spectrum or when the desired contrast feature is not seen by the sensor.

## Web Position Indicator

A horizontal bar graph, white bar in a black background, in the main operator interface is used to indicate the relative position of the web within the sensor range. The edge position or the contrast position is displayed using the white horizontal bar. The white portion indicates the web, specifically representing the light reflected/scattered back from a web, while the black background indicates the absence of web, specifically the darkness because of no reflection or scattering from the web.

Depending on the position and orientation of the sensor the white bar graph may move:

- from left to right for a sensor located on the right side of the web edge
- from right to left for a sensor that is located on the left side of the web edge.

When a wide sensor is connected and if the sensor is set to see both the edges, then both left and right edges of the web will be shown using the web position indicator. The vertical green line in the middle indicates the centerline position of the web.

When two sensors are connected, the bar graph will split in two, with the left half indicating the left edge of the web and the right half indicating the right edge of the web. If both sensors are the same

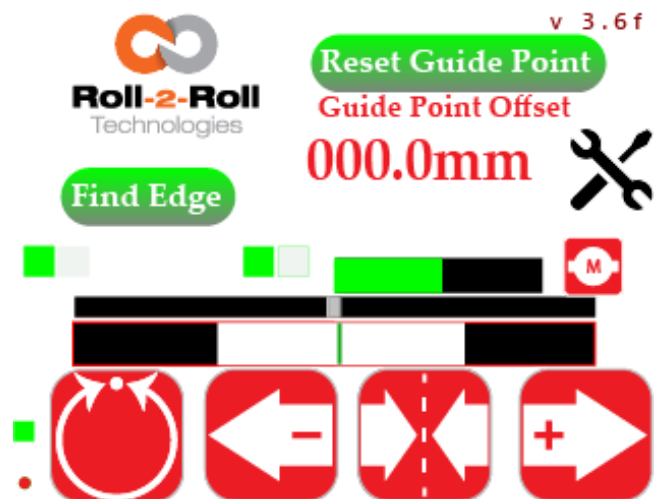
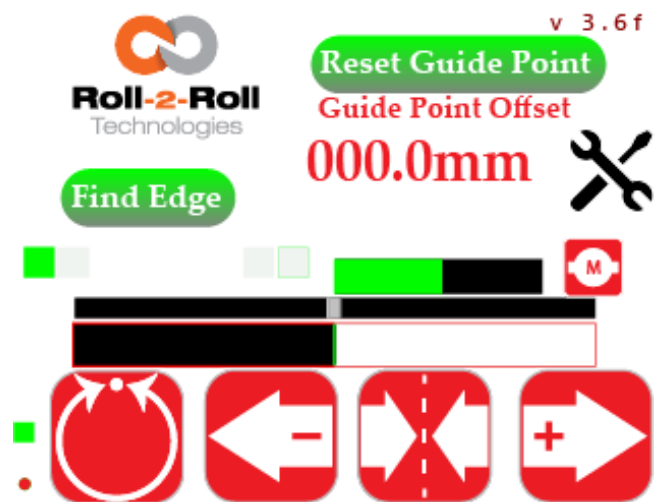

orientation, then web position from the sensor connected to Sensor 1 port will be displayed on the left and the right half indicating the web position from the sensor connected to Sensor 2 port.

When in contrast mode the white bar graph may turn into gray segments representing the various contrasts on the web and the contrast position indicated by a vertical green line.

## Sensor Orientation Indicator

The four sensor orientation indicators provide quick feedback on the orientation of each sensor. Each sensor can be oriented to pick the left edge, right edge or both edges. The two indicators on the left correspond to the left orientation for Sensor 1 and Sensor 2 while the two on the right correspond to the right orientation for the two sensors. When a particular orientation is chosen for a particular sensor the corresponding indicator will turn green; if not the indicator would appear gray.

## Find Edge Button

The find edge button is used by the operator to set the job appropriately based on the desired edge that is used for sensing and guiding purposes. The find edge button serves dual purpose based on the sensor configuration in the power user screen.

1. Automatically find the sensor orientation: When one or both sensors are set to detect the orientation automatically, pressing the find edge button will detect the correct orientation for the sensor(s) with respect to the web in the sensor's field of view.
2. Enable and disable the sensors: When both sensors are set a predefined orientation pressing the find sensor button will successively enable and disable the connected sensors electronically

### Automatically find the sensor orientation

The sensor orientation with respect to the web can be automatically detected in this mode when the find edge button is pressed. This allows for quick job changes when the sensor is repositioned within the machine. This is especially useful while using a single sensor that is repositioned to pick either the left edge, right edge or both edges.

This functionality is used whenever the sensor orientation with respect to the web is changed. For example, if the sensor is moved from the operator side to the drive side for a job, then as soon as the repositioning happens the find edge button can be pressed to switch the sensor mode from left edge to right edge (or vice versa). If both edges of the web are seen within the field of view of the sensor then the sensor orientation would change to center mode.

### Enable and disable the sensors

When the orientation of the sensors are fixed then the find edge button allows the user to quickly enable and disable the sensors for easy job change. For example, when two sensors are connected to the controller and are configured for a respective sensor orientation, then successive press of the find edge button would have the following effect:

- Enable sensor 1 and disable sensor 2
- Enable sensor 2 and disable sensor 1
- Enable both sensor 1 and sensor 2
- Disable both sensor 1 and sensor 2

## Automatic/Manual Icon



Manual



Automatic

The SCU5 controller, for web guiding applications, can be put into manual or automatic operation mode by pressing this icon. The press of the icon will toggle the controller between manual and automatic operation. When the controller is connected to an actuator and a web guiding system, the automatic mode will move the web guide structure based on the position of the web.

A few icons on the operator interface are enabled or disabled as the web guide is switched between manual and automatic mode based on the available options in each mode. Figure on the right shows the operator interface while the controller is in automatic mode. The advanced setup and the find sensor buttons are disabled.



**WARNING:** Changing from one mode to another can result in a change in the web guide position causing process upsets. Caution must be exercised when changing the operating mode and should be done by those who completely understand the consequence of this change.

**WARNING:** No personnel should be manually handling the web guide or the material around the web guide when the guide is in automatic operation. Failure to follow this warning could result in crushing of body parts at pinch points around and within the web guiding system.

**WARNING:** Care must be taken that only one person is working on the guide when it is in manual operation. Failure to follow this warning could result in crushing of body parts at pinch points around and within the web guiding system.

**NOTE:** This functionality has no meaning for sensing applications. However, some custom applications with custom firmware may use the functionality.

## Servo Center Icon



Default/normal state



Servo-centering ON

Pressing the servo center icon will initiate the servo centering operation for web guiding applications. This operation can be performed only when the SCU5 controller is in manual mode. Pressing this momentary switch will initiate the servo centering operation which would toggle the icon to green. When the controller is in servo centering mode, the actuator connected to the SCU5 controller will move towards the home position or center position which is provided by the servo center sensor, typically an inductive proximity switch. As soon as the actuator reaches the home or the center position, the actuator will stop and the state of the momentary switch will change from Servo-centering (Green) to Default/normal state (Red).

The servo center feature allows the guide to be centered quickly to facilitate threading of the web during changeover.

**WARNING:** Servo centering operation results in a change in the web guide position causing process upset. Caution must be exercised when performing this function and should be done by those who completely understand the consequence of this change.

**WARNING:** Servo centering can be performed only when the web guiding system is in manual mode. Pressing the servo center icon during automatic operation will perform a different function.

**WARNING:** This is an automatic procedure of the web guiding system. No personnel should be performing manual work on or around the guide during the servo-centering procedure. Failure to follow this warning could result in crushing of body parts at pinch points around and within the web guiding system.

**NOTE:** This functionality has no meaning for sensing application. However, some custom applications with custom firmware may use the functionality.

### Jog-left/Jog-right Icon



Jog-left OFF



Jog-right OFF



Jog-left ON



Jog-right ON

The Jog-left/Jog-right icons allow the operator to manually move an actuator connected to the SCU5 controller in either direction. These operations can be performed only when the controller is in manual mode. Both these icons act as a momentary switch that will turn ON (Green) when pressed and turn OFF (Red) when released.

The Jog operation will continue as long as the button is pressed and will stop as soon as the button is released. This operation can only be performed when the guide is in manual setting.



**WARNING:** Jog-Left and Jog-Right operations result in a change in the web guide position causing process upset. Caution must be exercised when performing these functions and should be done by those who completely understand the consequence of this change.

**WARNING:** Jog-Left and Jog-Right operation can be performed only when the web guiding system is in manual mode. Pressing the icons during automatic operation will perform a different function.

**WARNING:** This is a manual procedure of the web guiding system. No personnel should be performing work on or around the guide during the jog procedure. Failure to follow this warning could result in crushing of body parts at pinch points around and within the web guiding system.

**NOTE:** This functionality has no meaning for sensing application. However, some custom applications with custom firmware may use the functionality.

## Guide Point

The guide point is the desired reference position within the sensor window/range where the web needs to be positioned for web guiding applications. The guide point is the reference position which is used to compute the web position error for web guiding applications. When the web guide controller is in automatic mode the error between the guide point and the actual web position will drive the actuator in order to minimize the error.

Typically the guide point is set to the exact middle of the sensor window/range. However, the guide point can be changed electronically to any location within the sensing window.

## Guide Point Indicator

The guide point indicator which is on top of the web position indicator, provides a visual indication of the current guide point with respect to the sensor window/range. While in automatic mode, the web position will line up with the guide point indicator when the web guide is in normal operation.

## Guide Point Offset

The guide point offset from the middle of the sensor window/range is displayed as a signed numerical value in millimeters. When the offset is 0 then the guide point is exactly at the middle of the sensor window/range. When the offset is positive then the guide point is on the right half of the sensor window/range while when the offset is negative then the guide point is on the left half of the sensor window/range.

## Guide Point Adjustment

The guide point can be adjusted in two ways: fine guide point adjustment for small incremental adjustments and gross guide point adjustment for large step change to the guide point.

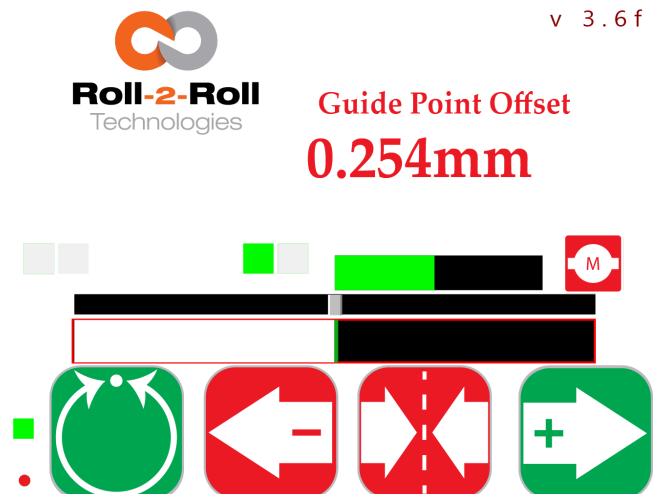

### Fine Guide Point Adjustment

Fine adjustment to the guide point can only be made when the web guide is in automatic mode. These adjustments enable small incremental changes to the guide through the operator interface to enable operators to move the desired guiding position of the web. The fine adjustment to the guide point can be made by pressing the left (-) or right (+) arrow icons on the operator interface while the web guiding system is in automatic mode. Every single touch of the left or right icon will respectively decrease or increase the guide point by 0.256 mm. This change is immediately displayed by the visual guide point indicator and the numerical guide point indicator. Pressing the middle icon (servo-centering icon) will reset the guide point to 50% or 0 mm guide point offset.

### Gross Guide Point Adjustment

The gross guide point adjustment is intended for making a large step change in the guide point, often after a product changeover especially with a web width change. This adjustment can be made by directly sliding the visual guide point indicator track bar to the desired location; the track bar can be moved only when the web guide is in manual mode.

The change in the guide point needs to be confirmed by pressing the “Accept” button that appears whenever the track bar is moved. The confirmation is intended to prevent any accidental changes to the guide point. If the guide point change is not accepted within 10 seconds the change will be disregarded and the previously accepted guide point will be restored.

**NOTE:** The pressing of the Left (-) or Right (+) during fine guide point adjustment will momentarily change the icon to green. With the release of the button the icon changes the color back to red.

**WARNING:** The guide point adjustment operation results in a change in the web guide position causing process upset. Caution must be exercised when performing this function and should be done by those who completely understand the consequence of this change.

**WARNING:** Fine guide point adjustment can be performed only when the web guiding system is in automatic mode. Pressing the Left (-) or Right (+) icons during manual operation will perform the jog operations.

**WARNING:** Guide point adjustment should be made only if it is necessary and should be carried out by personnel with good knowledge about the consequences of the change. The performance of the guiding system may deteriorate if the guide point is too far away from the desired 50% setting. Some of the changes might have no effect if the web guide is in an extreme position.

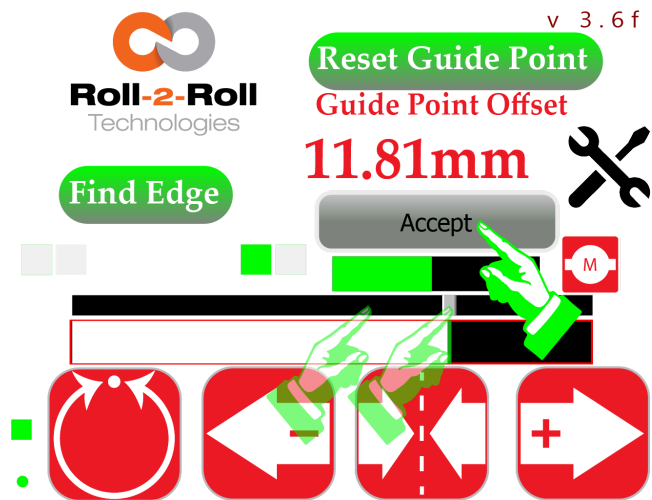

## Reset Guide Point

The reset guide point is intended to quickly change the guide point to the current web position. The feature is used in applications with frequent web width changes. Instead of manually moving the guide point using the gross or fine guide point adjustment, the guide point can be reset to the current edge position with the press of a button. When in manual mode, pressing the reset guide point button will automatically set the new guide point to the current edge position as shown.

The change in the guide point needs to be confirmed by pressing the “Accept” button that appears whenever the reset guide point button is pressed. The confirmation is intended to prevent any accidental changes to the guide point. If the guide point change is not accepted within 10 seconds the change will be disregarded and the previously accepted guide point will be restored.

**NOTE:** This functionality has no meaning for sensing application. However, some custom applications with custom firmware may use the functionality.

## Actuator Position Bar

The actuator position bar provides a real-time electronic position of the actuator. The extension and retraction of the actuator is shown by the movement of the green bar. As the actuator position approaches the extreme limits the bar changes color to yellow (alert) or red (warnings) indicating the closeness of the actuator position to its maximum electronic stroke limits (as shown below). Once the electronic limits are reached the actuator would no longer move in that direction, in which case the bar would be either completely red (fully extended) or completely black (fully retracted).

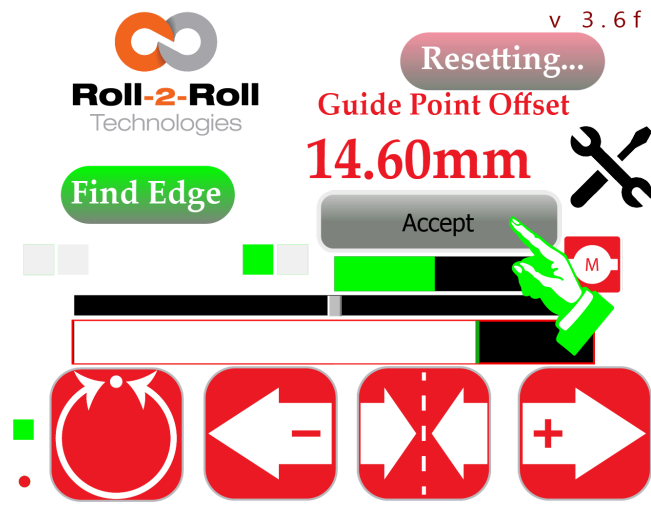

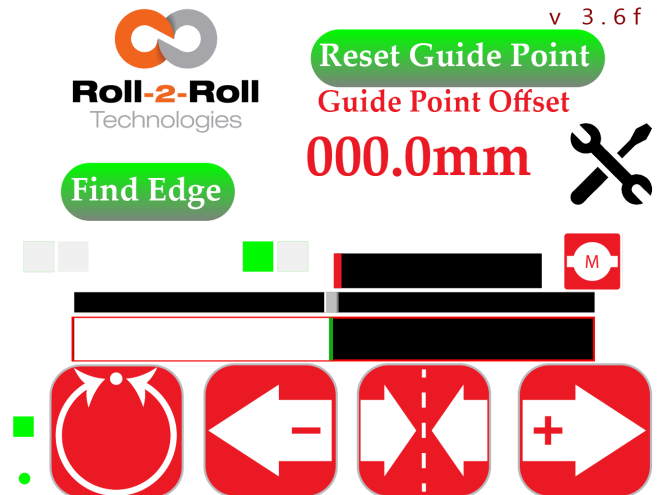
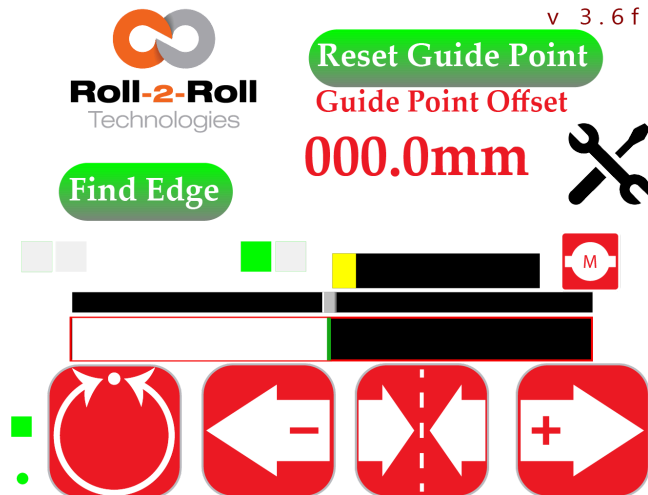
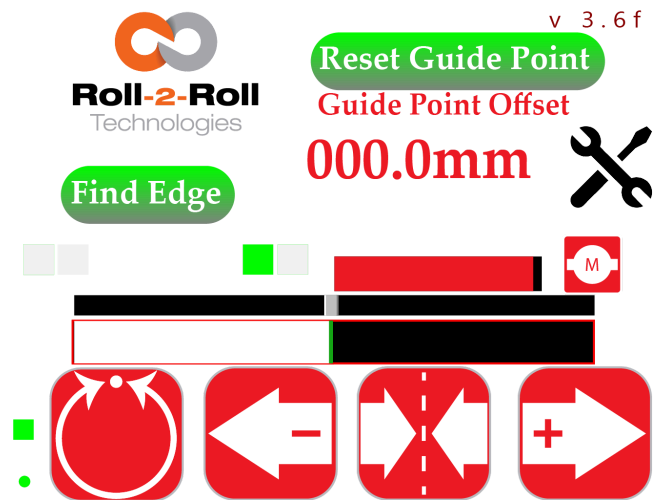
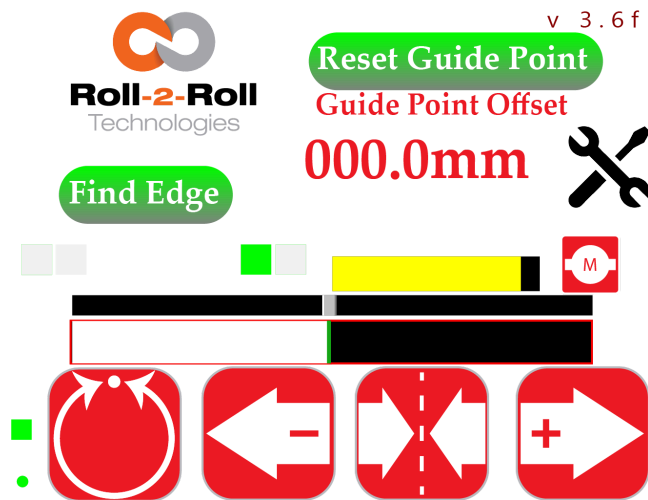

**NOTE:** The actuator position is the electronic step count position that is kept track on the Roll-2-Roll® Driver. Hence this is an open loop position when a stepper motor driver is used. If a servo drive is used, this could be the closed loop position.

**WARNING:** The actuator position bar should exhibit smooth real-time motion while the web guide is in operation. If the motion of the bar is choppy or intermittent, this indicates some communication issues between the SCU5 controller and Roll-2-Roll® Driver.

**WARNING:** If the actuator connected to the SCU5 moves but the actuator position bar does not indicate any movement (either completely black or red), this might be due to corrupted electronic position of the actuator in the memory. This is not normal and should be addressed immediately.

## Advanced Settings Menu

The SCU5 controller provides advanced settings both for the operator and the maintenance personnel. The advanced settings screen will allow operators, power users and maintenance technicians to adjust parameters to suit their measurement and web guiding needs. This screen can be accessed by pressing the Advanced Settings icon on the home screen.

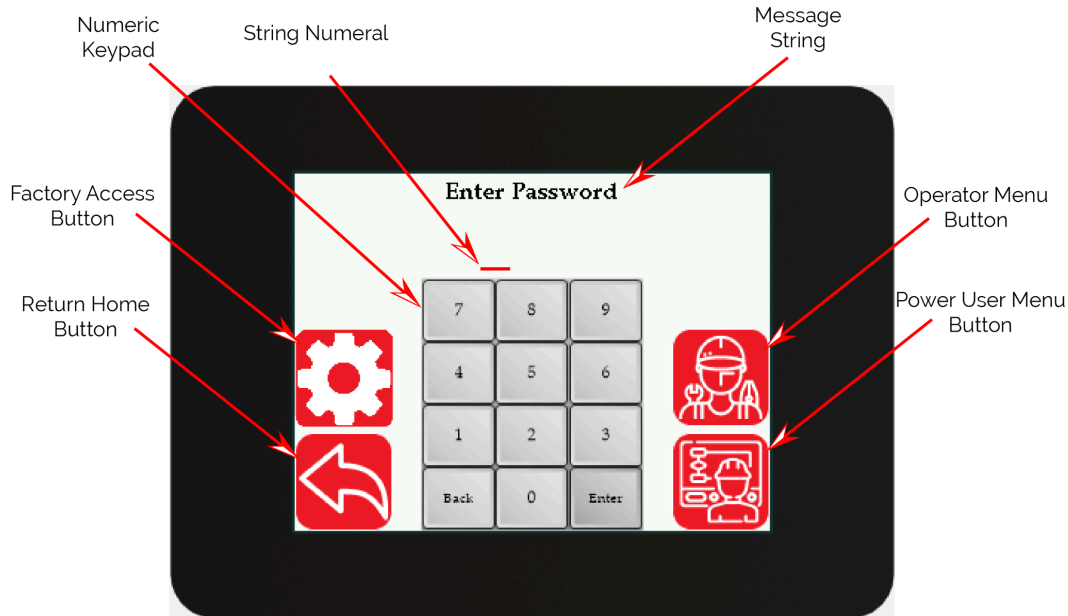

Access to these advanced screens can be restricted with passwords to prevent unintended changes to the settings by personnel not qualified to make such a change. Unique passwords are used for access to the operator screen and the power user/maintenance screen. The factory access is only available to Roll-2-Roll Technologies personnel.

By default the password protection will be disabled and both the operator icon and the power user icon are visible to the user. If password protection is enabled the two icons would disappear. The keypad can be used to type the appropriate password to gain access to the respective screen. Once the password is authenticated the respective icon would appear and touching the icon would provide access to the appropriate screen.



## Operator Settings Screen

The operator settings screen provides a menu to the operator sensor screen and the operator width screen to set jobs for contrast sensing, contrast guiding and width measurement applications.

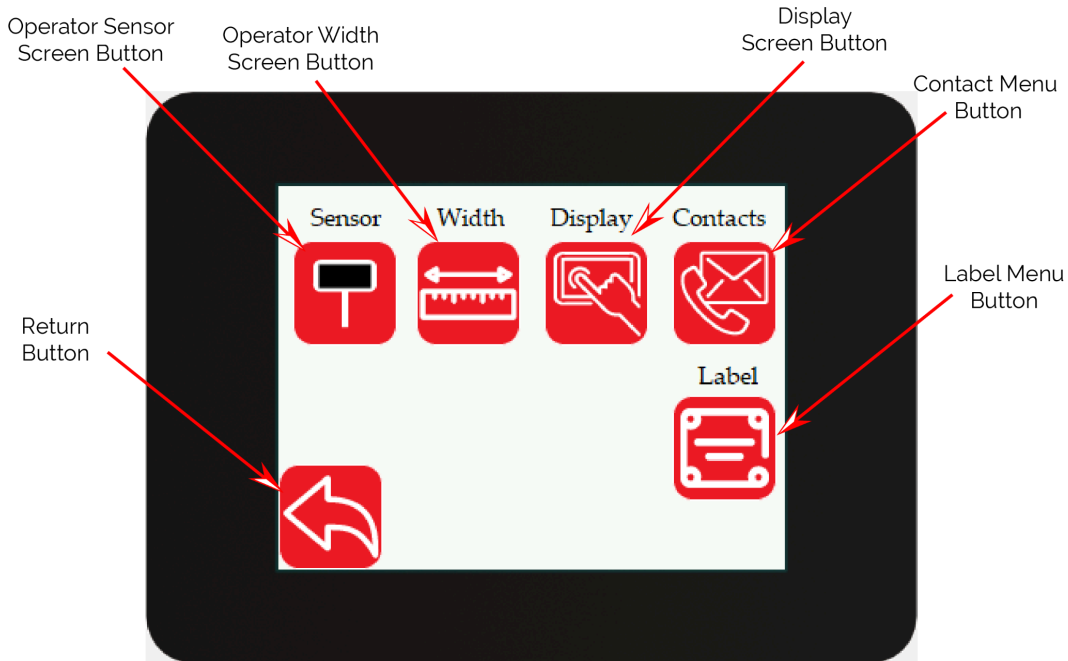

## Operator Sensor Screen

This screen provides access to several sensor functionalities that provide the user with complete control over the sensor image processing of the controller. Hence it is critical that the user is familiar with all the functionality to ensure proper operation of the controller.

### Sensor Mode

The operator can change the sensor mode from edge sensing to contrast sensing by toggling the sensor mode button. When the icon is black and white the controller operates in edge sensing mode. When the icon is black, green and white then the controller operates in contrast mode.

**NOTE:** If two sensors are connected to a single controller, the controller will process both the sensors with a single mode of operation. In other words the two sensors cannot have different modes of operation.

### Thresholding Mode

Thresholding mode can be set to either static or dynamic. For most applications the default dynamic thresholding (green icon with varying levels) would be the most appropriate choice. However, for some advanced applications the static thresholding (red icon with a flat line) could be used. This advanced feature should be used with caution.

**NOTE:** Each sensor can have its own independent thresholding mode.

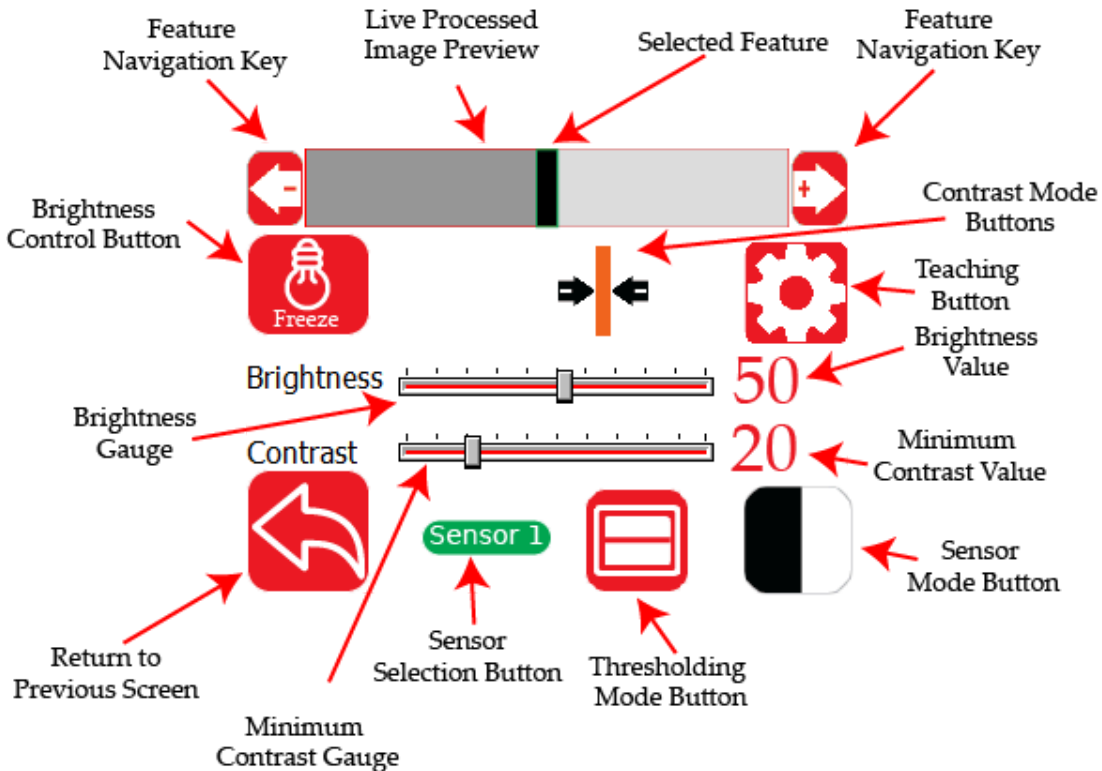
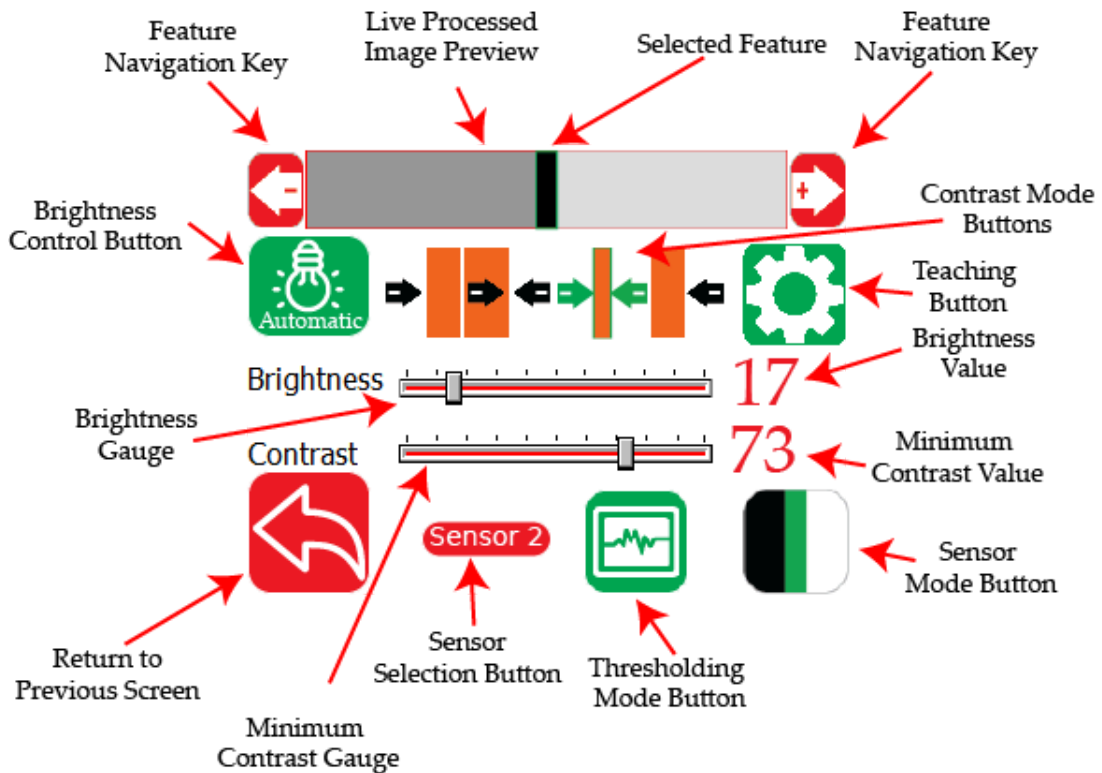

## Sensor Selection

Pressing the sensor selection button would allow the user to access the settings for the respective sensor. The button press will toggle between Sensor 1 and Sensor 2.

## Minimum Contrast Gauge

The minimum contrast that is required to detect an edge can be set using this contrast gauge and the corresponding numerical integer value is displayed to the right of the gauge. When the contrast value is lowered the controller becomes sensitive to small contrast changes in the image captured by the sensor. Hence more and more edges with low contrast will be picked by the controller. When the contrast value is set high, the edges with high contrast values will be seen while the low contrast edges would be disregarded.

The recommended minimum contrast value for edge mode is 10 and for contrast mode is 50.

**NOTE:** Set the minimum contrast as high as possible while the feature of interest is still visible. This will increase the robustness of the algorithm.

**NOTE:** When the thresholding method is static then the minimum contrast value directly corresponds to a scaled static threshold.

**NOTE:** Under certain conditions the user will not be permitted to change the minimum contrast value. This will occur in contrast mode when the controller is taught to track a certain feature on the web.

**WARNING:** If the sensing mode is contrast and if the minimum contrast value is too low or zero then the contrast detection algorithm will not function properly and would perceive every small change in the image. For contrast mode the recommended default value is 50.

**WARNING:** If the sensing mode is edge and if the minimum contrast value is too low or zero then the edge detection algorithm may pick only one edge even if multiple edges are present. For edge mode the recommended default value is 10.

## Brightness Gauge

When the brightness control is set to be in freeze mode, the gauge can be used to manually set the brightness. The corresponding numerical integer value is shown on the right of the gauge. The brightness can be changed from 0% to 100%.

**NOTE:** This feature is intended for advanced users and by default the brightness control should be allowed to change automatically.

## Brightness Control

The controller has an automatic brightness control algorithm that will change the brightness of the LEDs in the sensor based on the captured image. The algorithm helps to capture the best possible image based on certain criteria. The algorithm also helps with background suppression. The user can disable the automatic



brightness control algorithm to gain manual control over the LED brightness. Pressing the brightness control button will toggle the state of the brightness control algorithm to either automatic or freeze.

**NOTE:** *This feature is intended for advanced users and by default the brightness control should be allowed to change automatically.*

## Live Processed Image Preview

The rectangular box on the top shows a grayscale live preview of the processed image seen by the sensor. The different shades of contrasts seen by the sensor appear as rectangles in the image preview window. When a region of the web scatters a low amount of light back to the sensor, the region appears black or dark; while the region that scatters more light appears white or light. The grayscale value corresponds to the average light intensity within each region.

## Selected Feature

The controller can be taught to track a certain feature using one of the contrast modes. During teaching and after teaching, the selected feature that is being tracked is highlighted by a green bounding box. Depending on the contrast mode the bounding box may be a rectangle, three sided rectangle or two three sided rectangles.

**NOTE:** *If the taught feature is not seen within the sensor window then no bounding boxes will be visible. This would correspond to no valid contrast condition.*

## Feature Navigation

The left and right arrow keys can be used to scroll through the live processed image preview to select the appropriate contrasting feature of interest. Depending on the contrast mode chosen the arrow keys will move the edge or the line to the left or to the right.

**NOTE:** *The feature selection key can be used only when the controller is in teaching mode.*

## Teaching

When the controller is in teaching mode, the gear icon will appear green. The user can press the left and right feature navigation keys to navigate to the feature of interest. To save the teaching, so that the controller can follow the feature of interest, the gear icon can be pressed again. Successful teaching and saving of the feature of interest will turn the gear icon to red and all the contrast mode icons will disappear, except for the selected contrast mode.

**WARNING:** *When teaching is saved, the controller will look for the first appearance of the feature of interest from left to right. If there are two features with the same conditions within the sensor view, the left most feature would be selected. It is highly recommended to teach on a unique feature in the sensor view to increase the robustness of the measurement.*

## Contrast Mode

Four different contrast modes are available for the user to pick when the controller is in teaching mode. These include right edge of a color (or grayscale), edge created by two colors, the position of a line with a

certain color, and left edge of a certain color. When a certain mode is selected the region of interest is highlighted in the icon as shown below. When the teaching is successfully saved, the icon corresponding to the selected mode will be visible on the screen while all other three mode icons would disappear.

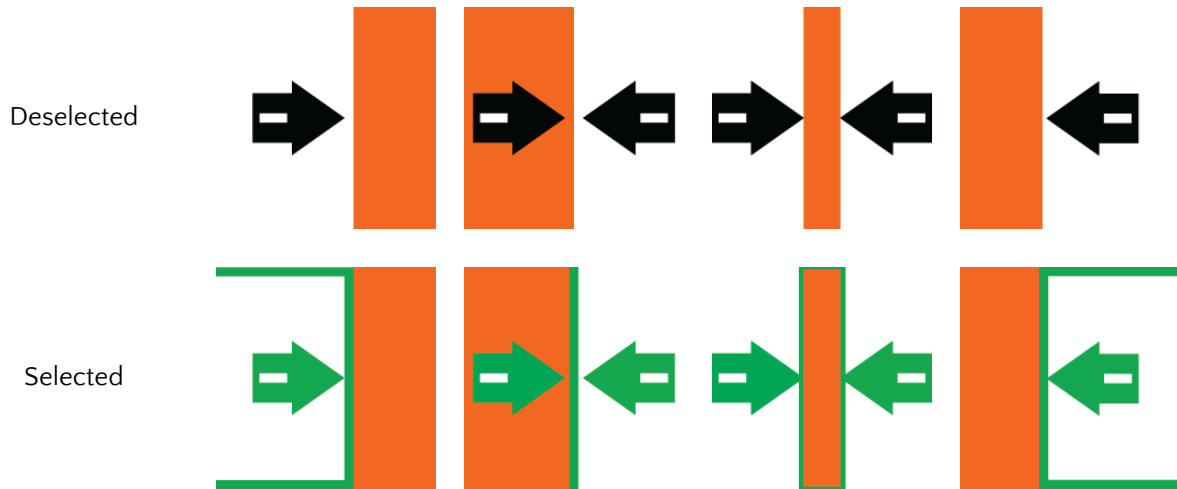

**WARNING:** If the teaching is not successful or if an invalid feature is picked then all four icons will be visible on the screen. Successful teaching will make three mode icons disappear while leaving one visible.

### Right edge of a color

In this mode the controller will look for the right edge of a certain color (or grayscale) as shown below. A three sided open rectangle will highlight the region of interest with the right edge of the color region highlighted in green. The user can press the feature navigation arrows to navigate to the region of interest. When the desired region of interest is highlighted, the teaching can be saved by pressing the gear icon. Once the teaching is saved, all other modes will disappear and the gear icon will turn red as shown below.

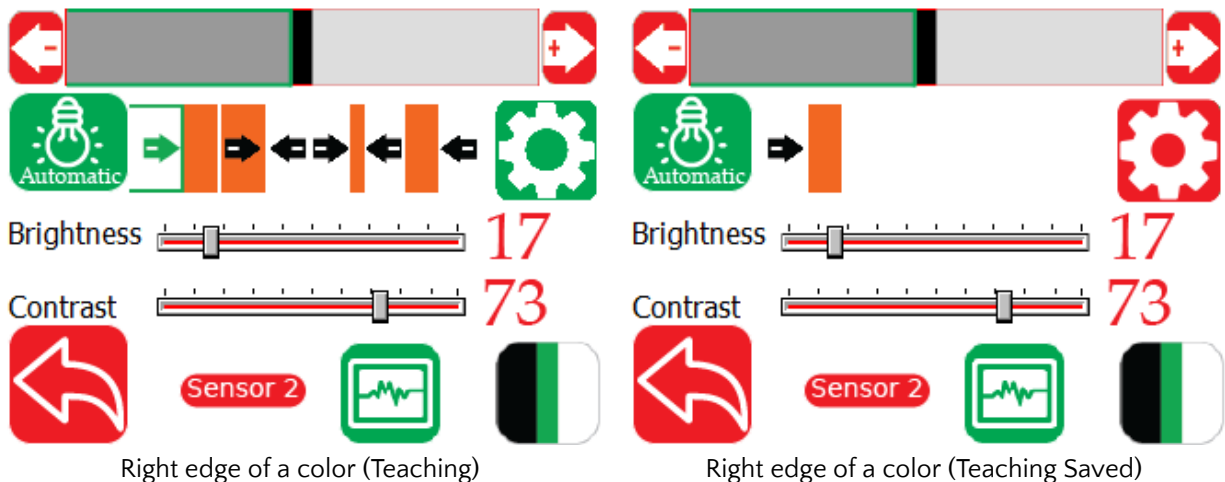

**NOTE:** In the above example the user cannot navigate to the rightmost region since the controller cannot see an edge for that color. The user will only be able to navigate to the middle black region.

**NOTE:** If more than one feature has the same color, the controller will only pick the first right edge with that color from left to right. It is not recommended to use this mode if two features on the web have the same color; Line mode or edge created by two colors may be a better option.

**NOTE:** When the teaching is successfully saved, indicated by the disappearance of all other mode icons, the user cannot change the brightness control state, the brightness gauge or the minimum contrast gauge.

### Edge created by two colors

In this mode the controller will look for an edge created by a certain color on the left and certain color on the right. Two regions will be highlighted along with the edge that is of interest (as shown below). The controller will look for the first appearance of the exact match of the edge with the two colors on either side with the appropriate order. Once the teaching is saved, all other modes will disappear and the gear icon will turn red.

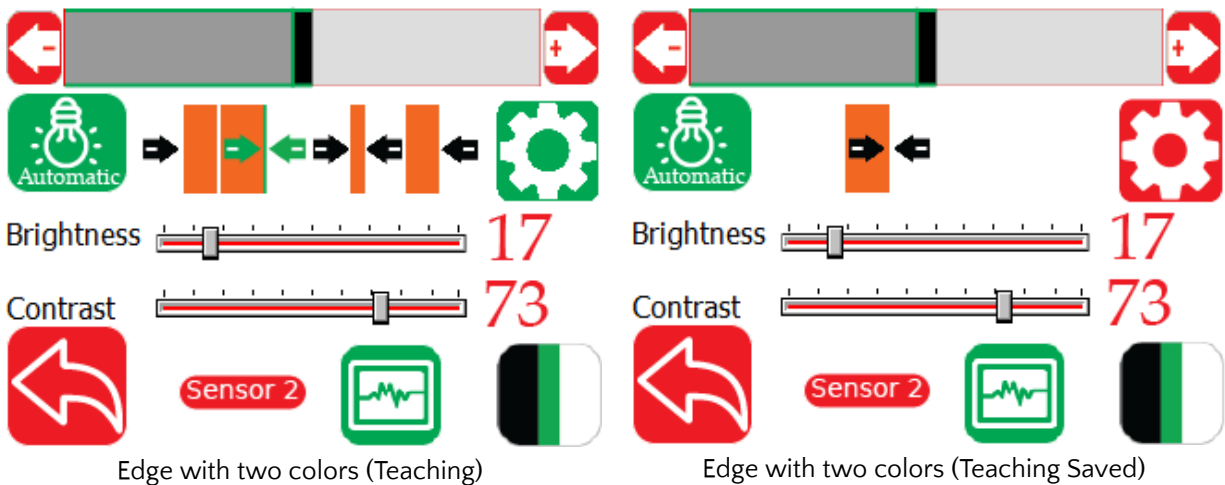

**NOTE:** The Order of the colors matters in this mode. In the above example if the sensor is taught from gray followed by black and if the order is reversed to black followed by gray (if the sensor is rotated 180°), the controller will not pick that edge even though the two color regions are the same.

**NOTE:** If multiple regions have the same color pair (such as in a barcode), the controller will always pick the first pair from left to right. In that case the right edge of the color mode would be a better choice.

**NOTE:** When the teaching is successfully saved, indicated by the disappearance of all other mode icons, the user cannot change the brightness control state, the brightness gauge or the minimum contrast gauge.

### Color of a line

In this mode any region with two edges can be used for tracking purposes. The controller will look for two conditions to track the feature: (1) color and (2) the width of the color region. Since two conditions need to be satisfied, this is one of the most robust modes. Once the teaching is saved, all other modes will disappear and the gear icon will turn red. Once the teaching is saved, the controller always pick the first occurrence of the color with a certain width while scanning from left to right

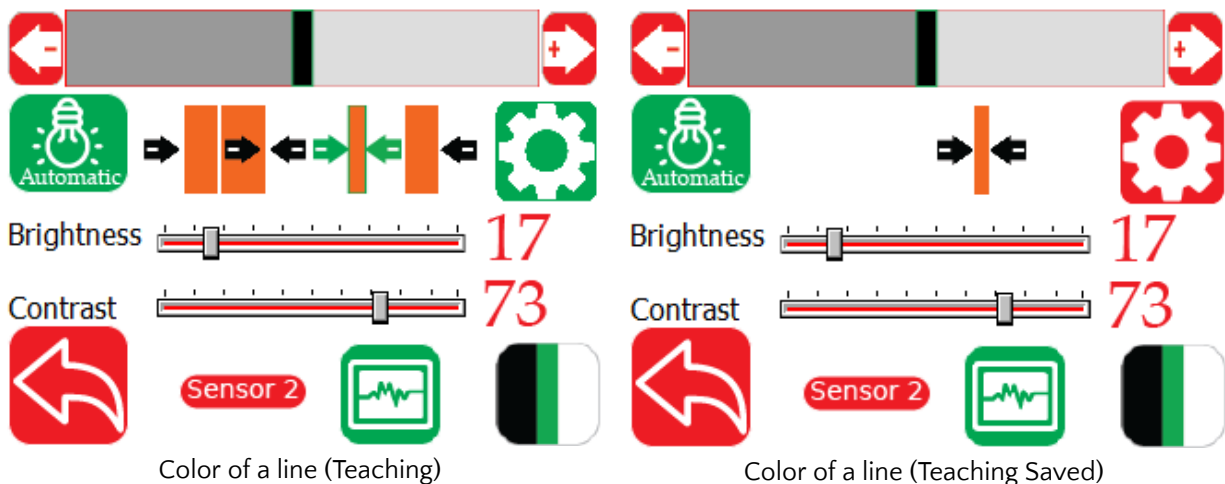

**NOTE:** In the above example the user cannot navigate to the rightmost region or the left most region since the controller cannot see both the edges for that color. Two edges for the certain color should be seen for the controller to lock on the line feature.

**NOTE:** If there are two lines with the same width and same color the controller will always pick the first matching line from left to right.

#### Left Edge of a color

Similar to the right edge of a color, this mode will allow the user to track the left edge of a certain color. In teaching mode, a rectangular region of interest and the left edge of that region will highlight the region. Once the desired region is selected the teaching can be saved by pressing the gear icon. If the saving is successful all other modes will disappear and the gear icon would turn red.

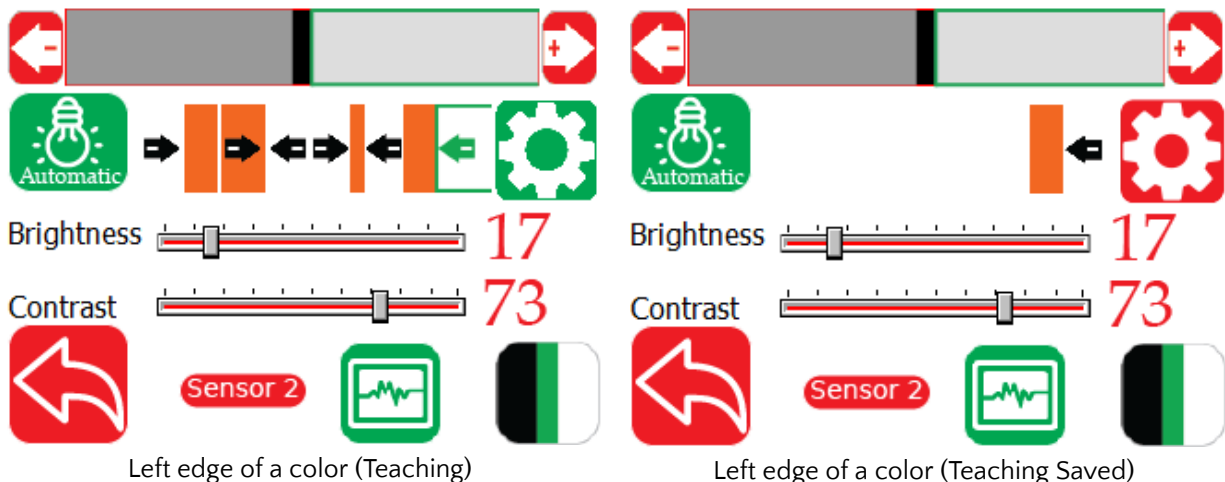

**NOTE:** While teaching, the controller will not scroll through a region without a proper definition of the feature in that respective mode. For example, the user cannot pick and teach for the leftmost region on the screen while in the left edge of a color mode. This is because the leftmost edge cannot be outside the

sensor viewing area. Similarly the controller will not pick the leftmost or rightmost region when in line mode since for a line both edges need to be visible in the sensor viewing area.

**WARNING:** While teaching, the controller would allow the user to pick a non-unique region of interest. However, after teaching the controller will always track the first occurrence of the non-unique region while scanning from left to right.

**NOTE:** No region will be highlighted if the feature of interest is not in the field of view of the sensor. This condition is called the “No Contrast” condition.

**NOTE:** While in automatic mode for web guiding, the web guide will automatically go to an interlock mode and will prevent the web guide to actuate whenever a no contrast condition is seen. As soon as the feature of interest reappears the web guide will actuate if the position of the feature is not at the desired guide point.

**NOTE:** When no contrast condition occurs, the analog output will provide the middle value of its output range. The digital output through ethernet would have a number equal to the total number of pixels in the sensor. Under normal operation, the digital contrast position output would range between zero and (number of pixels - 1). Whenever the value equals the number of pixels then it means no contrast condition.

## Operator Width Screen

For width measurement applications the operators can set the job by navigating to the width menu on the operator settings screen. If one sensor is used for width measurement, the controller should be in edge mode with sensor configuration to be in center sensor. If two sensors are used to measure web width, then the sensor should have the corresponding left and right sensor configuration for the respective edge of the web. It is also possible to measure (1) the width of a contrasting feature with two sensors, and (2) the width of two strips of web with two sensors. Please consult the factory for these advanced functionality.

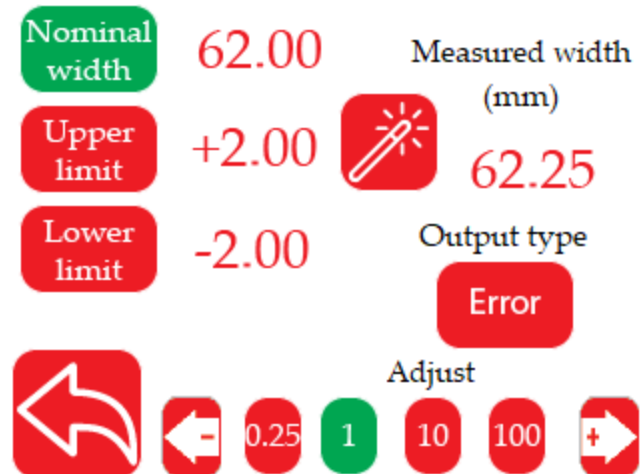

### Nominal Width

For each job the operator can set a nominal width (in millimeters) by pressing the nominal width button. When the button is highlighted in green the operator can change the value by using the -ve (left arrow) and +ve (right arrow) arrows on the bottom. Depending on the magnitude selected (pressing the appropriate magnitude value will highlight the button to green) each press can change the value by 0.25 mm, 1 mm, 10 mm or 100 mm. The nominal width value is used to compute the width error based on the measured width.

**NOTE:** The minimum value for nominal width that can be set is 1 mm and the maximum value is 9750 mm.

**NOTE:** When the width is more 99.75 mm the display will only show one decimal place even though the nominal width can be set to any multiple of 0.25 mm. Similarly when the nominal width is more than 999.75 mm the display will only show integer values. However, if the nominal width is incremented by 0.25 mm increments, the controller will still record those without displaying the decimal places.

## Upper Limit

When the measured web width is more than the nominal web width then the width error is positive. With an appropriate output on the SCU5 controller a fault signal can be generated when the positive width error is more than the upper limit. If the error is equal to the upper limit, no fault signal would be generated.

**NOTE:** The controller will not check to see if the upper limit is more than the nominal width.

**NOTE:** The minimum value for the upper limit that can be set is 1 mm and the maximum value is 99.75 mm.

## Lower Limit

When the measured web width is less than the nominal web width then the width error is negative. With an appropriate output on the SCU5 controller a fault signal can be generated when the negative width error is less than the lower limit. If the error is equal to the lower limit, no fault signal would be generated.

**NOTE:** The controller will not check to see if the lower limit magnitude is more than the nominal width.

**NOTE:** The minimum value for the lower limit that can be set is 1 mm and the maximum value is 99.75 mm.

## Measured Width

The measured width provides a real time width value based on the image captured by one or two sensors. The measured width is the sum of raw measurement from each sensor plus any offset. Offset is often necessary when the width is measured with two sensors. Since the controller does not know the actual distance between the two sensors, the offset is necessary to compute the measured width based on the raw width measurement from the sensor(s).

**NOTE:** The measured width will update only with correct settings. For example, if one sensor is connected and the sensor is set to left mode, the measured width value will not update.

### One Sensor

When one sensor is used for width measurement, the sensor should be wide enough to see both the edges of the web even when the web wanders in the cross-machine direction (width wise movement). The sensor mode should be in edge mode with the sensor configuration to be in center to see both the edges. The measured width is the raw width plus the offset. The offset is still valid for one sensor however it may be a small value. The offset is used to compensate for working distance and focus corrections.

### Two Sensors

When two sensors are used for width measurement, each sensor should be installed with appropriate orientation, i.e., one sensor should see the left edge of the web and the other the right edge. For most applications the sensor mode should be in edge mode. The measurement from each sensor is the amount of web seen by each sensor, which is the raw width. If the two sensors are exactly butted against each other

then the sum of the two sensors would be the web width. If the two sensors overlap each other if they have a gap between them, then the offset is either negative or positive. Hence the measurement width would be the sum of web covered by each sensor plus the offset.

**NOTE:** *If both the sensors are in the same orientation the width measurement would still work but the display on the front screen would show both edges moving in the same direction with a black gap in the middle.*

**NOTE:** *If sensing mode is contrast, the two sensors have to be positioned a certain way to get the correct contrast width measurement. Please consult the factory for more detailed documentation for such an installation.*

## Teaching

When the user presses the teaching wand, the controller will automatically calculate the offset based on the raw sensor(s) measurement at that instant. The offset is computed by subtracting the raw sensor(s) measurement from the nominal width.

In order to record the correct offset the user should present a web of known width (preferably the known width is equal to the nominal width) at the desired working distance from the sensor(s), ensuring that both edges of the web are seen by the sensor(s). If that known width is different from the nominal width, then that value can be entered as the nominal width before pressing the teaching wand. As soon as the wand is pressed, the controller will calculate the offset. If the nominal width is different from the known width used for teaching, then the appropriate nominal width can be reset.

**NOTE:** *When the teaching wand is pressed the controller will compute the offset using this equation:  $offset = nominal\ width - raw\ measurement\ from\ the\ sensor(s)$ . The offset is not shown on the display however the measurement width will be shown. Since the measured width is offset plus the raw measurement from the sensor(s), the measured width will be the same as the nominal width (if the web is stationary).*

**WARNING:** *Pressing the teaching wand will reset the offset based on the current measurement.*

**NOTE:** *The offset can be reset to zero by pressing the teaching wand when no web is in front of the sensor(s).*

## Output Type

When an analog output is used for width measurement, the analog output type can either be the absolute width measurement or the error in width measurement. Pressing the button will toggle the state between the absolute and error output.

### Absolute

When the output is set to absolute, the digital width measurement displayed on the home screen will provide the measured width value in mm. The analog output on the other hand would be scaled to range from null scale to full scale based on the range of the sensor and the range of the analog output. For example, with a 48 mm sensor a web width of 24 mm would have an analog output value of 5 V if the analog

output range is set to 0 to 10 V. However, the same 24 mm width for a 112 mm sensor would be 2.14 V if the analog output range is set to 0 to 10 V.

**NOTE:** The user has to scale the output to convert the output into an absolute width value based on the sensor range.

### Error

When the output is set to error, the digital width measurement displayed on the home screen will provide the error between measured width value and nominal width value in mm. The analog output on the other hand would be scaled to range from null scale to full scale based on the error. If the error is zero then the analog output would be exactly one half of the full scale range of the analog output. For example, if the analog output range is 0 to 10 V the output would be 5 V if error is zero. If the error is positive then the output would be more than 5 V and if the error is negative then the output would be less than 5 V. Unlike the absolute output type, the magnitude of error in mm and the magnitude of voltage change on the analog output would not change based on the sensor range. For example, if the error is 2 mm irrespective of the sensor range the analog output would always be ...

**NOTE:** The analog output setting (which can be set as shown in the following sections) should be set to width in order for the width measurement to function properly.

**NOTE:** It is intuitive to see the output when the voltage ranges to  $\pm 10$  V or  $\pm 5$  V for this mode.



### Display Screen

The brightness of the SCU5 controller can be adjusted using the slider on this screen. Additionally the display units can be changed from millimeter to inch by pressing the display units icon.

### Power User Screen

When the power user icon is pressed on the advanced settings menu, the power user is presented with a menu of options. These options include settings for the actuator, sensor, controller, analog output, password protection and communication. Access to the respective settings are available by clicking the respective icon.

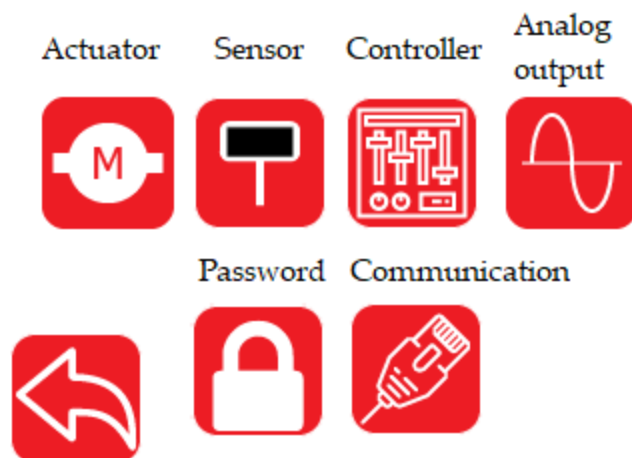



**WARNING:** Changes to these settings can have a significant effect for both sensing and guiding applications. Wrong settings can cause damage to the actuator, web guide or devices connected to the SCU5 controller. Hence only those well versed in the operation of the web guiding system or the measurement/sensing system should change these settings.

## Actuator Setting

The actuator setting screen allows the power user to set the actuator parameters such as stroke length, lead screw pitch, actuator speed, acceleration, the motor polarity and the servo center polarity.

**WARNING:** The actuator parameters are typically preset from the factory and should only be changed with consultation with the factory. Except for speed and acceleration all other parameters need not be changed once the web guiding system is commissioned for operation.

**NOTE:** The actuator parameters are intended to be changed by maintenance personnel with sufficient knowledge about the web guiding system and its performance. Most often these settings are changed during initial commissioning, after an actuator upgrade or replacement and/or with after a retrofit installation.

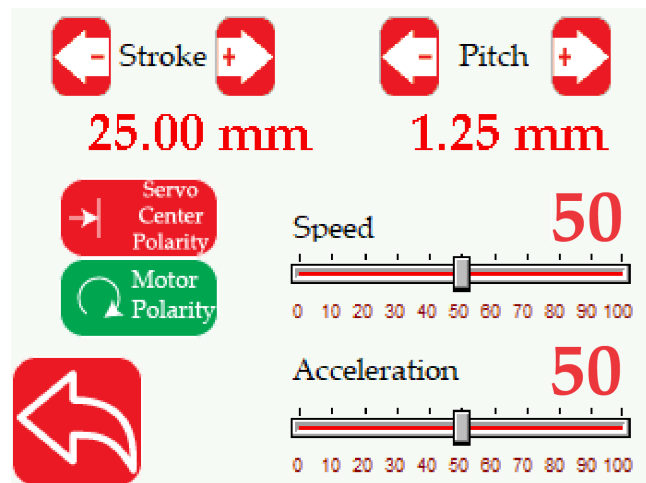

### Stroke

The digital stroke length can be changed in multiples of 5 mm and can be incremented or decremented using the + and - keys. This digital stroke setting is used to keep track of the distance the actuator can move on either side from the servo centered position. Hence from the middle position (servo centered position) the actuator will travel half the stroke length on either side. This digital stroke length setting helps prevent the actuator from hitting the mechanical limits and prevent any motor damage in the event that the actuator moves when no web is present.

**NOTE:** The actuator position is tracked digitally using software and the actuator stops actuating once the digital limits are reached. The digital limit of the actuator may not correspond to the physical limits of the actuator or the web guide structure. These digital limits are available to prevent the actuator from hitting the mechanical limits and to avoid any possible motor burnout.

**WARNING:** Never set the stroke length more than the physical stroke length of the actuator. Setting a stroke length more than the physical stroke available in the actuator may cause actuator damage.

**WARNING:** Never set the stroke length more than the physical stroke length available on the web guide structure. Setting a stroke length more than the physical stroke available may cause actuator damage.

**NOTE:** The servo center position is used to reset the digital position count to zero whenever the actuator reaches the servo center position.

## Pitch

The pitch setting is used to set the lead screw pitch. This setting is pre-set at the factory and should not be changed without consultation with the factory. The pitch can be incremented in multiples of 0.25 mm.

**WARNING:** Changing the pitch setting would affect the digital position count of the actuator and hence the effective stroke of the actuator. Setting the pitch higher than the actual pitch would reduce the effective stroke length and vice versa.

**WARNING:** Never set the pitch to a value that is less than the actual pitch. This can result in the actuator reaching its mechanical limits and possible actuator damage.

## Motor Polarity

The motor polarity setting is used to reverse the direction of the actuator. This setting changes the behavior of the actuator both in automatic mode as well as in manual mode. Depending on the sensor installation the motor polarity needs to be reversed to make sure that the automatic correction is in the right direction.

**WARNING:** If the motor polarity is set incorrectly the web guide structure will move in the opposite direction of the desired correction when in automatic mode. This is an immediate indication of the incorrect setting.

## Servo Center Polarity

The polarity of the servo center can also be changed in order to accommodate various locations for the sensor installation. This may be necessary if the location of the servo center is changed or if a different type of servo center sensor is used.

**WARNING:** If the servo center polarity is set incorrectly the actuator will move away from the middle position when the servo center button is pressed. This might cause the actuator to hit the mechanical limits and might cause damage to the actuator.

## Speed

The actuator speed can be increased or decreased using the slider. The value set indicates the percentage of the maximum and minimum speed setting for the actuator.

**WARNING:** When the speed is set to 0% the actuator will not respond in the automatic mode.

## Acceleration

The actuator acceleration can be increased or decreased using the slider. The value set indicates the percentage of the maximum and minimum acceleration setting for the actuator. Higher acceleration may result in lower thrust output from the actuator.

**WARNING:** When the acceleration is set to 0% the actuator will not respond in the automatic mode.

## Sensor Setting

Power users have the ability to change several settings for each sensor to enable advanced capability of the controller. These settings include the ability to turn on and off the automatic brightness control algorithm, manually set the brightness of sensor(s) LEDs, enable or disable the sensor that is connected to a controller and manually force the position state of the sensor(s).

## Automatic Brightness Control

One of the advanced features of the controller is to automatically adjust the brightness of the LEDs in the sensor for background suppression purposes. The default factory setting is to have the automatic brightness control ON. However, the power user has the ability to freeze and manually set the brightness to an arbitrary value depending on their application needs. Pressing the brightness icon will toggle the state between Automatic and Freeze.

**WARNING:** Disabling the automatic control should be performed only for challenging applications where the automatic brightness control is not performing as desired. This operation should be carried out only by those who have good knowledge about the application.

**WARNING:** Manually setting the brightness too high would disable the background suppression algorithm so this should be carried out only by the power user who is knowledgeable and aware of its consequences.

**WARNING:** Manually setting the brightness too low may prevent the controller from seeing the web. Never set the brightness to zero without consulting the factory about the application.

**NOTE:** If the sensor mode is set to contrast then the state of this button cannot be changed.

## Brightness Value

The percentage brightness of the LEDs is displayed as a three digit integer and using the brightness gauge. If the brightness control is disabled (or in Freeze mode) then the user can manually set the brightness of the LEDs for the respective sensor.

**NOTE:** If the sensor mode is set to contrast then the brightness cannot be changed manually.

**NOTE:** If the sensor mode is set to edge and the automatic brightness control is enabled then the brightness cannot be changed manually.

## Enable/Disable Sensor

For certain applications it may be necessary to disable a sensor that is connected to the controller. An example application would be one in which two sensors, located at two positions or locations, are used to

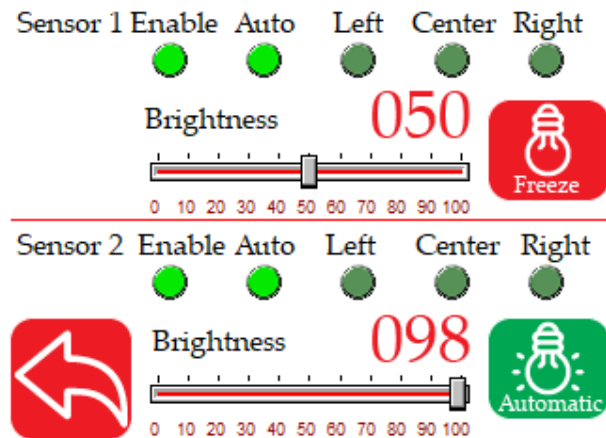

control a single web guide structure or an actuator. However, only one sensor is used at a time for the feedback control.

By default both sensors are enabled as part of the default factory settings. Pressing the button will toggle the state between enabling and disabling the sensor. Bright lime green indicates that the sensor is enabled while a dull green indicates that sensor is disabled.

**WARNING:** Unless the application requires the sensor(s) to be disabled, always leave the sensor(s) enabled with the factory default setting.

**NOTE:** Disabling a sensor electronically will have the same effect as unplugging the sensor physically.

## Sensor Position/Orientation Setting

Power users also have the ability to force the sensor position/orientation state depending on their application. The states can be one of the following: Auto, Left, Center or Right. When the state is set to Auto the find sensor button on the front screen can be used to automatically detect the sensor position/orientation based on how the web is presented. For certain situations the user may prefer to manually set the state of the sensor to Left, Right or Center.

In edge sensing mode the sensor will look for the web edge scanning from the outside to the inside of the sensor. For a left sensor the scan goes from left to right, while for a right sensor the scan goes from right to left. A center sensor state is one in which both the edges of a web are within the field of view of the sensor.

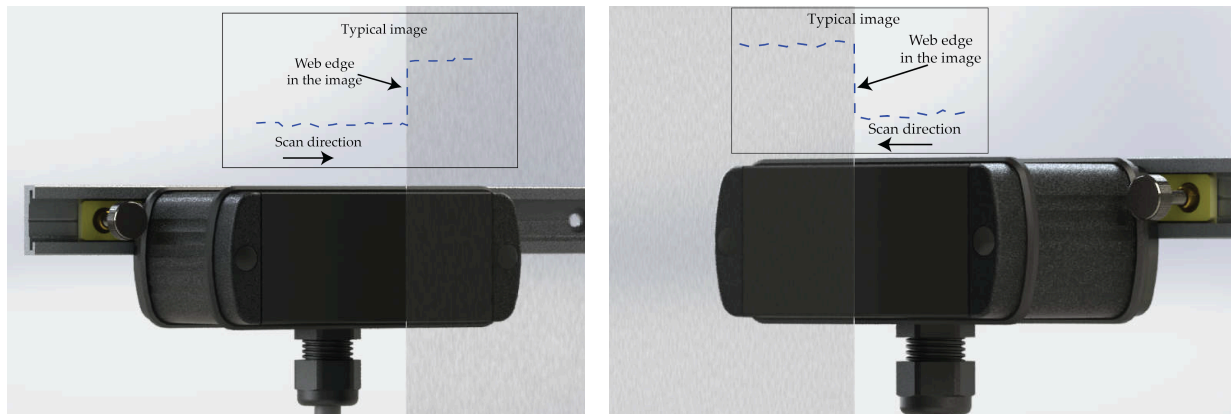

*Left sensor orientation (left) and right sensor orientation (right)*

**NOTE:** The sensor state is always defined based on relative position of the web with respect to the sensor. For example, in the picture on the left above if the sensor is rotated upside down, which the cable gland on the top, then the sensor orientation would change to right sensor.

**WARNING:** If the sensor state is forced to Left, Right or Center, disconnection and reconnection of the sensor will not automatically set the state as in the Auto mode. Everytime the sensor position is changed, with respect to the web, the power user is responsible for ensuring the correct state of the sensor.

## Controller Setting

When the SCU5 controller is used for web guiding purposes the controller settings such as gain, deadband, etc. can be set from this screen.

### Gain

The gain setting needs to be changed based on the actuator lead screw and the mechanical advantage of the web guide structure. The gain value sets the maximum distance the actuator would move based on the error magnitude. Unlike conventional controllers, the Roll-2-Roll SCU5 web guide controller is a complex non-linear position based controller which has independent settings for position gain, velocity and acceleration of the actuator. The maximum stable gain setting for the actuator or web guiding system depends on the pitch of the lead screw, the microsteps of the driver, the mechanical advantage of the web guide structure. Typically the controller is preset with the recommended gain values from the factory.

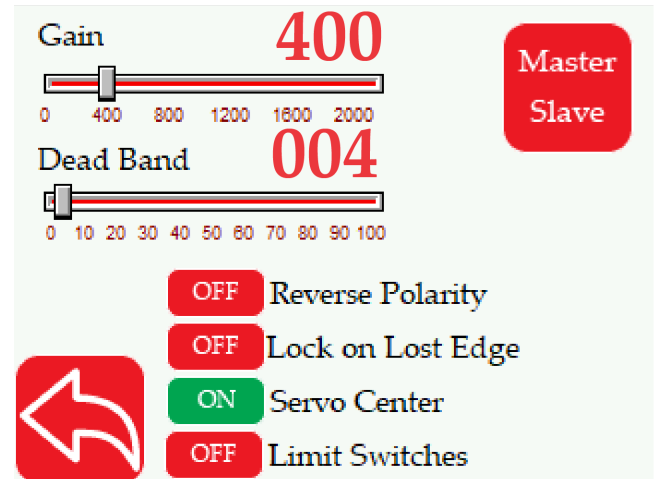

**NOTE:** If the gain is set to zero then the actuator will not respond to any error when in automatic mode.

**NOTE:** The gain setting is independent of the speed and acceleration setting.

**WARNING:** This parameter may affect the stability of the overall web guiding system and hence should be changed with care.

### Deadband

Deadband is the region around the guidepoint where the actuator will not be actuated if the web is within this deadband. This integer value is in pixels and by default the deadband value is 4 pixels or 0.25 mm. With that setting, the actuator will not move if the web is within  $\pm 4$  pixels or  $\pm 0.25$  mm from the guidepoint. Setting a deadband of zero will make the actuator move as long as the error is non-zero.

**NOTE:** Wider deadbands can be used for webs with ragged or irregular edges.

**NOTE:** Setting the deadband to zero will make the actuator move all the time. It is not advisable to set the deadband to zero.

### Reverse Error Polarity

The error polarity for the web guiding system can be reversed by turning ON the reverse polarity button. This might be needed based on the web guide installation as well as the sensor installation.

**NOTE:** If the polarity is set wrong, then the web guide will go to an extreme position as soon as the controller is in Automatic web guiding mode.

## Lock on Lost Edge

For some applications it may be necessary to prevent the actuator from moving when a web edge is not seen within the sensor window. By setting this parameter to ON the actuator will stop moving when no web is seen by the sensor. This is similar to the automatic interlock mode that is available in the contrast guiding application

**NOTE:** *This setting is only applicable for edge guiding applications since it is by default implemented for contrast guiding.*

**NOTE:** *This setting is only applicable for single edge guiding with one sensor since it is by default implemented for center guiding with one or two sensors.*

**NOTE:** *The actuator will move if the web is completely covering the sensor window. And the actuator would stop moving only when no web is seen by the sensor. When two sensors are used both the sensors should see no web for this feature to function.*

## Servo Center

The servo center functionality is typically implemented with an inductive proximity sensor that looks for the home/middle position. It is possible to disable the use of an external proximity sensor and just use the internal motor position counts. This parameter enables or disables the use of an external proximity sensor for servo centering purposes. It is always recommended to use an external servo center sensor since the sensor will reset/recalibrate the position tracking of the controller.

**WARNING:** *If an external servo center sensor is enabled but no servo center sensor is installed, the actuator will still move until the physical limit is reached. This might cause the actuator to hit against its mechanical limit and can cause damage to the actuator. However, the controller will automatically recognize the absence of the servo center sensor and will perform a different routine to bring the actuator back to the middle of its stroke. This might take a while depending on the actuator stroke and speed settings. If the controller does not find the servo center sensor, it will automatically switch the servo center sensor back to OFF.*

**WARNING:** *If servo center polarity is set incorrectly, the controller will perform the above routine. Hence if that happens the servo center polarity has to be reversed before turning this servo center switch back ON.*

**WARNING:** *If the inductive proximity sensor is installed too far away from the target to actuate the switch the servo center routine may not find the home/middle position.*

**NOTE:** *If the servo center switch is turned off, pressing the servo center button would move the actuator to the digital home/middle position. This position may not be the home/middle position for the actuator.*

## Limit Switches

For high dynamic response or high load applications, where the controller is pushed to get the best possible speed and acceleration performance, it may be necessary to install physical limit switches since the digital position count from the controller may not be accurate. In those cases the limit switch can be turned ON. Alternatively, for safety application these limit switches can be used to stop the actuator from moving when a guard door is open.

**NOTE:** Disabling the limit switch will only disable the physical limit switch. The electronic limit based on the actuator stroke will still be enabled to stop the actuator from moving if the position count is reached electronically.

**NOTE:** If the limit switches are used for safety application both the left and the right limit switch should be connected together to a single actuator inhibit signal.

**WARNING:** If the limit switch is enabled but the physical switches are not installed correctly, then the actuator will not move at all. Even the Jog and Servo Center functionality will be disabled.

## Master Slave

The SCU5 controller can be used for master slave or chase follow systems in web guiding applications. These systems require two sensors. One sensor tracks the position of the master web, and the other guides the slave web. This configuration is common in lamination applications, where the slave web needs to be guided to the same location as the master web.

To enable master slave mode, press the "Master Slave Off" button. By default, Sensor 1 is the master, and Sensor 2 is the slave. The user can change this state if necessary by pressing either sensor button. In master slave mode, the web guide uses the slave sensor position to guide to a guidepoint. The guidepoint of the slave sensor is dynamically changed based on the master sensor web position, ensuring perfect synchronization of the two webs. Depending on the sensor installation, the polarity for the guidepoint change can also be adjusted.

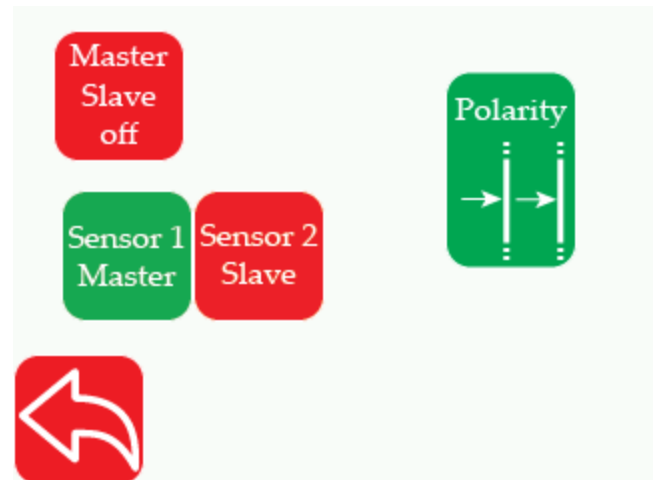

## Analog Output Setting

### Output range selection

The analog output setting can be changed based on the application. The voltage ranges and the current ranges can be set by picking the appropriate selection. The available voltage options are 0 to 5 V, 0 to 10 V,  $\pm$  5 V and  $\pm$  10 V. The available current options are 0 to 10 mA, 0 to 20 mA, 0 to 24 mA and 4 - 24 mA.



**NOTE:** Any combination of the voltage and current setting can be selected, except when 0 - 10 mA is selected the voltage output is automatically set to 0 - 5 V.

### Analog mode

While in edge mode the controller can be programmed to provide the position of the left edge, or right edge or centerline position or the web width or the web coverage. The analog mode can be changed only if the sensor sees both edges of the web. Selecting the appropriate analog mode button will enable the user to accomplish the functionality.

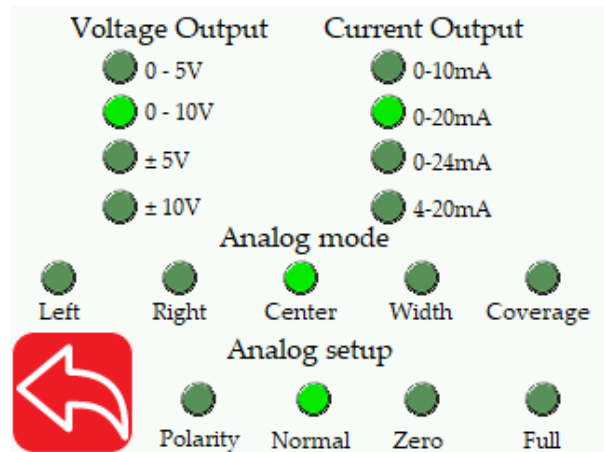

**NOTE:** When only one edge is seen by the sensor or when the sensor is in single edge mode, the analog mode cannot be changed. The controller will automatically select the appropriate edge and by default will provide the single edge position through the output.

**WARNING:** For width measurement application, the analog mode should be set to width even if the controller is not equipped with an analog output port.

**WARNING:** Analog mode cannot be changed if the controller cannot provide the appropriate output.

### Analog setup

The controller can be programmed to provide the zero scale value or full scale value by pressing the appropriate button. This functionality is useful while calibrating a legacy system. After calibration the controller can be switched back to normal operation by clicking on the Normal Op button. The polarity of the analog output can also be changed by pressing the polarity icon. When the polarity icon is pressed the value would be inverted from the full scale value.

**NOTE:** The controller will switch back to normal operation as soon as the user leaves the analog setup screen.

### Password Setting

This screen allows the power user to enable or disable the password protected for both the power user screen access and operator sensor screen access. Pressing the button will toggle the password enable/disable option. When the locked icon is displayed, the password for the respective screen will be enabled.

**NOTE:** Please contact the factory for the passwords for the respective screens.

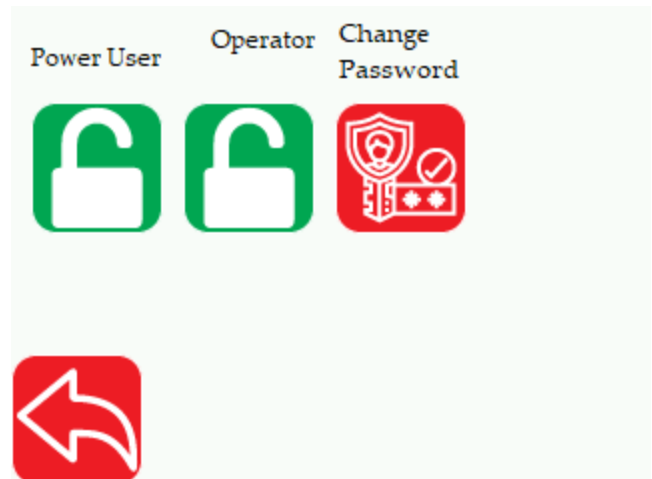



**NOTE:** The passwords for the respective screens cannot be changed. However, if a custom 4 digit password can be created with a customer firmware change.

## Communication Setting

### Ethernet

The ethernet ON/OFF button shows the state of the ethernet communication. This switch cannot change the state and is used only for viewing.

### DHCP

If the DHCP is set to ON the SCU5 controller (client device) will get the IP address from a network server or a router. The IP address, and other network parameters, would be assigned dynamically and may change after a power cycle if the server or router initiates the change. When the DHCP is set to OFF then the controller will use a static network information (such as the IP address, subnet and gateway) that is set on the controller manually.

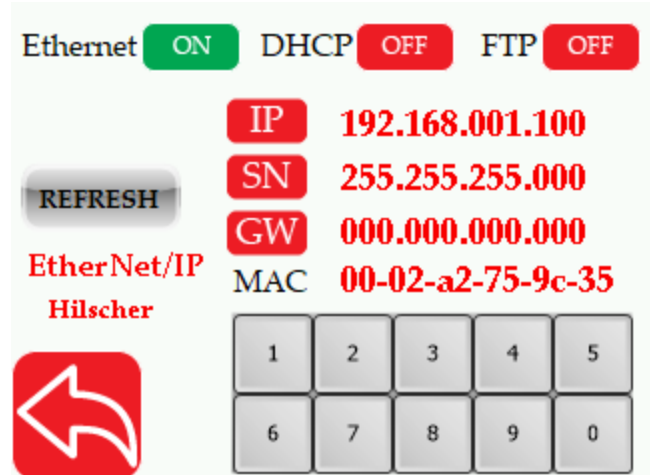

**NOTE:** The state change from OFF to ON requires a power cycle of the controller. In later versions of the firmware this reset may happen as soon as the SET button is pressed.

**WARNING:** Do not press the refresh button after setting the DHCP OFF. Immediately power cycle the controller. In certain Hilscher modules pressing refresh could set the static IP address back to the factory default value.

**NOTE:** The DHCP can also be set using the IPConfig utility or other network software directly through the network.

**NOTE:** With Hilscher Modules when the DHCP is ON, the IP Address, Subnet Mask, Gateway values on the SCU5 controller might be all zeros. Please use the network software to directly search for the IP address of the SCU5 controller using the mac address.

### FTP

This setting would enable or disable the FTP server on the SCU5 controller. This is an advanced feature and should not be changed without consulting with the factory.

**NOTE:** The default state is OFF.

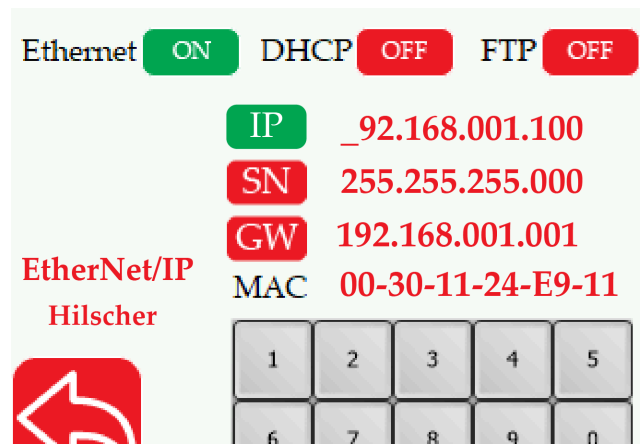

## IP

The IP address of the SCU5 controller can be viewed and changed here. If the IP address button is pressed it will allow the user to set the IP address. The user will be able to set a valid 32-bit address value by entering four 8-bit values (3 digits each) using the keyboard. The address can be set by pressing the set button which will appear when a valid IP address is entered.

**NOTE:** *The IP address can be set only when the DHCP is set to OFF.*

**NOTE:** *With Hilscher modules, the IP address may be all zeros when DHCP is ON. Please use an appropriate network device to search for the IP address of SCU based on the mac address displayed.*

## Subnet Mask and Gateway

Both the subnet mask and the gateway for the network can be viewed in a similar fashion as the IP address. Same rules for setting these parameters are applicable.

**NOTE:** *Changing the IP address, subnet mask and/or gateway requires the controller to be power cycled.*

**NOTE:** *If any of the 3 digits is more than 255 the digits do not correspond to a valid 8-bit number. The whole address would be reset to zero and the user would have to start entering the numbers again.*

**NOTE:** *Entering a valid 8-bit number in each field does not mean that the value would be accepted by the network. The network constraints should be followed for these settings to take effect. The only way to verify that the new settings were accepted is by power cycling the device.*

**NOTE:** *The refresh button is useful only when any of the settings are changed by a network device or through the network. Changing the settings through the SCU5 controller and hitting refresh will not change the settings unless the controller is power cycled.*

**NOTE:** *The set button will appear only after successful entry of the respective values. All the three fields can change before pressing the set button.*

## MAC address

The MAC address of the ethernet module on the SCU5 controller is displayed here. This value cannot be changed.

## Module Type

The type of the industrial ethernet module in the SCU5 controller will be printed over the network LED. The available fieldbus options are EtherNet/IP, PROFINET, EtherCAT and Modbus/TCP. If no module is available on the SCU5 controller then the module type would be None.

## Network IC Type

Some versions of the SCU5 controller also identify the type of network IC installed. The two options are HMS and Hilscher. If the correct network IC is not initialized then it will appear as none.

**NOTE:** *If all of the address fields and the mac address is zero, then the ethernet module is not initialized. Make sure to turn ON ethernet and power cycle the controller. If the problem persists, you may not have an ethernet module on your controller or the ethernet module on the controller is faulty. Please consult the factory for more information.*

# REMOTE CONTROL AND MONITORING

A set of input and output registers are available to monitor and control the web guide controller remotely using industrial ethernet communication such as EtherNet/IP or PROFINET. The remote control and monitoring is available for advanced end users, OEMs and integrators to seamlessly integrate the web guide controller into their existing machine. For more information about these advanced features please consult the factory. It is possible to control/operate the web guide controller without an operator interface and directly using the industrial ethernet connection. The following section describes the advanced settings for industrial communication.

## EtherNet/IP Connection Parameters

Starting from version 3.6 two different ethernet modules (HMS and Hilscher) are used. An appropriate EDS file may be used to import the module in the PLC. In case a manual setup is performed then the following information may be used to set the module as a generic EtherNet/IP module in the PLC.

	Assembly Instance	Size	Bit
Input	100	16	16-bit
Output	150	8	16-bit
Configuration	1	0	8-bit

## PROFINET Connection Parameters

Ethernet module configuration value based on the PROFINET GSDML file.

Input Module	100	32	Bytes
Output Module	150	16	Bytes

NOTE: For PROFINET systems the 16-bit data from the controller are split into two bytes and byte swapped. The register map shown below is how the 16-bit data is stored in the sensor and sent out through the ethernet network. The PROFINET PLC might read the data in little endian format with the least significant byte first. So the 16-bit data from the sensor would need to be byte swapped to read the correct 16-bit value.

## EtherCAT Connection Parameters

Ethernet module configuration value based on the supplied ECS File. The EtherCAT master will set all the information automatically based on the FMMU setting in the ECS file. The information provided is only for reference.

Input	0x1100	32	8-bit
-------	--------	----	-------

Output	0x1D00	16	8-bit
--------	--------	----	-------

### Controller Output and PLC Input

#	bit 15	bit 14	bit 13	bit 12	bit 11	bit 10	bit 9	bit 8	bit 7	bit 6	bit 5	bit 4	bit 3	bit 2	bit 1	bit 0
0	Sensor 1 Fault and Status Codes															
1	Sensor 2 Fault and Status Codes															
2	Sensor 1: Left Edge															
3	Sensor 1: Right Edge or Contrast Position															
4	Sensor 1: Coverage															
5	Sensor 2: Left Edge															
6	Sensor 2: Right Edge or Contrast Position															
7	Sensor 2: Coverage															
8	Sensor 1 QF								Sensor 2 QF							
9	Web guide status/fault register															
10	Guide point offset															
11	Motor Speed Percentage								Motor Acceleration Percentage							
12	Sensor 1: Thread Count															
13	Sensor 2: Thread Count															
14	Sensor 1: Mean Width or Total Web Width															
15	Sensor 2: Mean Width or Total Web Width															

### Sensor status and fault registers

The sensor status/fault register is organized as follows. The eight least significant bits correspond to fault information while the eight most significant bits correspond to status information.

Bit #	Value	Label	Description
0	0/1	No sensor	0: if a sensor is present

			1: if no sensor is connected
1	0/1	Low contrast	0: if measurement contrast is high 1: if measurement contrast is low
2	0/1	No web	0: if web is detected by the sensor 1: if the sensor cannot detect a web
3	0/1	Wrong orientation	0: if sensor orientation is correct 1: if the sensor see an edge in the opposite orientation to which it is set up
4	NA		Reserved for future use
5	0/1	Flutter	0: if no flutter is detected 1: if the sensor detects flutter or out of plane movement in the web
6	NA		Reserved for future use
7	0/1	WPS or ODC	0: WPS Sensor 1: ODC
8	0/1	Left Sensor	0: if the sensor not set as a left sensor 1: if the sensor is set as a left sensor
9	0/1	Right Sensor	0: if the sensor not set as a right sensor 1: if the sensor is set as a right sensor
10-13	1-15	Number of pixels	The number of pixels in the sensor and the corresponding sensor resolution. When bit 7 is zero: 0: 256 WPS 16 (0.0635 mm) 1: 768 WPS 48 (0.0635 mm) 2: 1774 WPS 221 (0.125 mm) 3: 896 WPS 112 (0.127 mm)

			5: 1792 WPS 112 (0.0635 mm) 6: 1772 WPS 221 (0.127 mm) 7: 3544 WPS 221 (0.0635 mm) 8: 3554 WPS 440 (0.127 mm)  When bit 7 is set to 1:  1: 760 ODC 48 (0.0635 mm) 2: 764 ODC 96 (0.127 mm) 3: 1536 ODC 96 (0.0635 mm) 4: 1526 ODC 192 (0.127 mm) 5: 3052 ODC 192 (0.0635 mm) 8: 3042 ODC 384 (0.127 mm) 12: 6074 ODC 768 (0.127 mm)
14-15	0/2	Sensing mode	0: edge sensing mode  2: contrast position sensing mode

Note: If both the left sensor and the right sensor bits are set then the configuration corresponds to center sensor mode. A single sensor may be used to measure the position of the two edges of the web, if the width of the web is smaller than the sensing window of the sensor.

### Sensor 1/Sensor 2 Left Edge

If sensing mode is edge, then this register will provide the left edge of the web.

**Note:** *If the sensor orientation is set to the right sensor then this value would be zero.*

**Note:** *If the sensor orientation is set to the right sensor or if the sensor mode is contrast, then this value would be meaningless.*

### Sensor 1/Sensor 2 Right Edge or Contrast

If sensing mode is edge, then this register will provide the right edge of the web. While in contrast mode this register will provide the contrast position. In edge mode this register value is meaningful with either the right sensor or with center sensor.

**Note:** *While in contrast mode if the sensor sees no contrast then this value would equal to the number of pixels in the sensor.*

In either sensor orientation (left or right) the measured position increases as the web moves from left to right.

**Note:** *If no sensor bit is set or if no web bit is set then the value in the sensor position output register is meaningless.*

Sensor Orientation	Completely open	Fully covered
Left sensor orientation	Number of pixels	0
Right sensor orientation	0	Number of pixels

**Note:** *The output when the web completely covers the sensor or when the web is completely outside the sensor window would be different based on the sensor orientation.*

**Note:** *If a single web (with two edges) is seen by the sensor, then the width of the web can be obtained by taking the difference between right and left edge positions.*

**Note:** *If a single web (with two edges) is seen by the sensor, then the centerline of the web can be obtained by taking the average of left and right edge position.*

## Sensor 1/Sensor 2 Coverage

The sum of individual widths of webs is provided as the coverage value. Individual width is defined as the region between two rising edges on an image captured. When one web with two edges is present, the coverage value will equal the web width. When multiple webs are present, then the coverage value would correspond to the sum of individual widths.

**Note:** *When only one web (with both edges within the sensor field of view) is presented to the sensor the coverage value will be the same as the web width, The coverage value is computed based on edges seen by the controller. Hence, based on the controller settings if multiple contrasting features on the web are seen, then coverage value will not be the same as the web width.*

**Note:** *The complement of coverage is the gaps. So if a web is completely covering a sensor's viewing area, then a gap in the web can be detected by seeing a drop in coverage value. Sum of all gaps = Number of Pixels - Coverage.*

**Note:** *This measurement is an instantaneous raw measurement for each sensor. Enabling and disabling the filter in the controller will have no effect on the measurement output.*

## Quality Factor Registers

The quality of the sensor measurement from the two sensors are provided in this register. Higher numbers correspond to good quality measurement while a low number indicates lower quality. The value of the quality factor ranges from 0 to 256. The eight most significant bits of register 6 correspond to the 8-bits quality factor from sensor 1 while the eight least significant bits correspond to the quality factor of sensor 2.



## Web guide status and fault registers

Bit #	Value	Label	Description
0	0/1	No operator interface	0: if no operator interface is detected 1: if an operator interface is detected
1	0/1	No motor driver	0: if no motor driver is detected 1: if a motor driver is detected
2	0/1	Motor fault detected	0: if motor motor function is normal 1: if a motor fault is detected
3	0/1	Disturbance detected	0:if no disturbance is detected 1: if a disturbance is detected
4	0/1	Traction issue detected	0: if no traction issue is detected 1: if a traction issue is detected
5	0/1	Upstream misalignment	0: if no upstream misalignment is detected 1: if an upstream misalignment is detected
6	0/1	Guide extreme position	0: if the web guide is within the normal position 1: if the web guide is in an extreme position
7	0/1	High frequency disturbance detected	0: if a high frequency disturbance is detected 1: if no high frequency disturbances are detected
8	0/1	Manual/Auto	0: if the web guide is in manual mode 1: if the web guide is in automatic mode
9	0/1	Jog Left operation	0:if the web guide is not jogging left 1: if the web guide is jogging left

10	0/1	Jog Right operation	0: if the web guide is not jogging right 1: if the web guide is jogging right
11	0/1	Servo Centering operation	0: if the web guide is not servo centering 1 if the web guide is servo centering
12	0/1	Good guiding performance	0: if the guiding performance is not good 1: if the guiding performance is good
13-15	NA		Reserved for future use

### Guide point percentage

The guide point for the web guide is provided in this register. 16-bit signed integer guidepoint offset is provided in this register. When the guide point is changed on the screen or through the remote industrial ethernet interface, this register can be used to verify the change.

### Actuator speed percentage

The positioning speed of the actuator as a percentage of maximum speed is provided in most significant bits of register 7. The value ranges between 0 and 100.

### Actuator acceleration percentage

The acceleration of the actuator as a percentage of maximum acceleration is provided in the least significant bits of register 7. The value ranges between 0 and 100.

### Sensor 1 Thread Count

When multiple webs or strings or threads are viewed by the sensor, the number or the count of threads is provided in the register.

### Sensor 2 Thread Count

When multiple webs or strings or threads are viewed by the sensor, the number or the count of threads is provided in the register.

### Sensor 1 /Sensor 2 Web Width

When the SCU5 controller is set to provide the width, these registers provide the width output from the controller. Registers 14 and 15 are combined to provide a 32-bit value. The most significant 16-bits are provided in register 14 and the least significant 16-bits are provided in register 15.

**Note:** The web width measurement provided in this register is in the number of pixels. In order to convert that measurement to engineering units the conversion is as follows: 1 pixel = 0.0635 mm or 1 pixel = 0.0025 in.

**Note:** The web width measurement output includes the compensation factor that is calculated during the teaching process. For example, when two sensors are used to measure the two edge positions, the width measurement output includes the compensation based on the distance between the two sensors.

**Note:** The register will have a valid output only after the controller is taught for the nominal web width on the SCU5.

**Note:** If the filter is enabled the output provided would be the filtered output.

When the SCU5 controller is not set to provide width, then the registers provide the mean widths of the webs seen by each sensor. Register 14 will provide the mean width of the webs seen by sensor 1 and register 15 will provide the mean width of the webs seen by sensor 2.

**Note:** The mean width is computed by adding all the widths of the webs seen by each sensor and dividing it by thread count. This measurement is an instantaneous raw measurement for each sensor. Enabling and disabling the filter in the controller will have no effect on the measurement output.

## Controller Input and PLC Output

#	bit 15	bit 14	bit 13	bit 12	bit 11	bit 10	bit 9	bit 8	bit 7	bit 6	bit 5	bit 4	bit 3	bit 2	bit 1	bit 0
0	Sensor 1 Command Register															
1	Sensor 2 Command Register															
2	RLC	RBL	Maximum Brightness Limit						Minimum Brightness Limit							
3	S2A	S2BO	Sensor 2 Brightness Override Value				S1A	S1BO	Sensor 1 Brightness Override Value							
4	Guide command register															
5	Guide point offset register															
6	EN	Motor speed percentage register						EN	Motor acceleration percentage register							
7	Reserved for future															

## Sensor Command Register

The bits in the command register are organized as follow:

Bit #	Value	Label	Description
0-1	0, 2 or 3	Sensor orientation	0: set sensor orientation to be right sensor 2: set sensor orientation to be left sensor 3: set sensor orientation to be center sensor
2	0/1	Sensing mode	0: set the sensing mode to be edge mode 1: set the sensing mode to be contrast mode
3-5	0-7	Analog mode	0: Analog output is disabled.  1: Analog output is enabled and zero scale voltage/current is output. Note: This mode can be used during calibration while connecting the controller to a third-party controller that requires calibration. During the calibration, this mode can be selected to calibrate for zero scale output.  2: Analog output is enabled and full scale voltage/current is output. Note: This mode can be used during calibration while connecting the controller to a third-party controller that requires calibration. During the calibration, this mode can be selected to calibrate for full scale output.  3: Analog output is enabled and the analog output corresponds to the left edge position.

			<p>Note: When the sensor is uncovered by the web the zero scale analog value would be output. As the web moves left to cover the web, the analog value would increase and reach the full scale value when the web completely covers the sensor.</p> <p>4: Analog output is enabled and the right edge position is output. Note: When the sensor is uncovered by the web the zero scale analog value would be output. As the web moves right to cover the web, the analog value would increase and reach the full scale value when the web completely covers the sensor.</p> <p>5: Analog output is enabled and the center line position is output. The centerline position is the average of the left and the right edge position of the web. Note: If only one edge is seen the output would be the average of the edge position within the window and the extreme position corresponding to the unseen edge.</p> <p>6: Analog output is enabled and the width of the web is output. The width is computed by taking the difference between the rightmost edge position and the leftmost edge position. The analog output is proportionally scaled based on the sensor range. The ratio of the web width to the sensor range is output through the analog. If two sensors are used then the width would only correspond to the portion of the web that is seen by each sensor.</p> <p>7: Analog output is enabled and the web coverage is output. The coverage is the percentage of the sensor covered by web(s). This is used when webs can have gaps or voids in them. Unlike width output, which takes the leftmost edge and the rightmost edge, the coverage will not include the gaps/void between the leftmost edge and the rightmost edge.</p> <p>Note: There is only one analog output while two sensors can be connected to the controller. Please be aware that enabling the analog output for the sensors would result in unpredictable results. Always disable one sensor while selecting the output of the other sensor.</p> <p>Note: If the sensor orientation is left sensor or right sensor then the analog mode selection value of 3 – 7 will have no effect. The analog output would always correspond to the respective orientation.</p> <p>Note: The analog mode 2 has the highest priority followed by mode 1. If any one of the sensors have these bits enabled then the analog output will always provide the high or low output based on the priority. Always disable one sensor while selecting the output for the other sensor.</p>
6	0/1	Find sensor	<p>0: Disable find sensor operation 1: Enable find sensor operation by resetting the orientation and allowing the sensor to detect the web orientation. Note: This bit is momentary when set to one. Every time the find sensor operation needs to be enabled the bit needs to be cleared to zero before setting it to one.</p>

7	0/1	Disable Auto Switch	0: Enable the auto switch functionality for sensor orientation. Find sensor will work only when this is cleared to zero. 1: Disable auto switch functionality so that the sensor orientation can be forced remotely. This bit must be set to one before bit 0 and bit 1 can be changed.
8-13*	0-64	Minimum contrast	Minimum contrast: Minimum contrast required to accept an edge in contrast mode. Default value is 32.
14*	0/1	Reserved	Reserved for future
15*	0/1	Static Threshold	0: Static thresholding algorithm 1: Dynamic thresholding algorithm

\* A previous version of the firmware used all eight bits for contrast. The actual contrast value can only change from 0 - 100 on the display. The latest version would allow remote input between 0 and 63.

## Sensor Brightness Command Register

### Remote Light Control (RLC)

Bit 15 on register 2 has to be set to 1 to allow remote control of LED brightness to take effect. If this bit is cleared to zero, changing any of the other bits in register 2 and 3 would have any effect on the LED brightness.

### Remote Brightness Limit (RBL)

Bit 14 on register 2 allows the user to set brightness limits remotely. In normal operation the brightness of the individual sensors are allowed to vary from 4% to 100%. However, power users can change that limit through ethernet by setting this bit and writing values to the two remaining 7-bit registers.

### Maximum and Minimum Brightness Limit

The maximum value for the brightness of the LEDs can be written to bits 13 - 7 while the minimum value can be written to bits 6 to 0.

**Note:** *These maximum and minimum limits are for both the sensors even though the brightness for individual sensors may be different. The upper limit cannot be smaller than the lower limit value.*

**Note:** *If bit 15 is not set (or cleared to zero), this will have no effect.*

**Note:** *The limit value set through ethernet can change from 0 to 125 while the limit value set from the controller can change from 0 to 100.*

**Note:** *The limit will take effect even when the brightness is changed manually as well as if allowed to change automatically.*

**WARNING:** *When the ethernet connection is removed or disabled, the limits will be set permanently on to the controller settings. So if the controller would ever be used for standalone operation make sure to rewrite the lower limit to 5 and the upper limit to 125.*

### Sensor 1/Sensor 2 Automatic Brightness Control (S1A and S2A)

The automatic brightness control can be enabled or disabled by setting and clearing the appropriate bits in register 3. Bit 15 and Bit 7 in register 3 control this functionality. When the bits are set, the brightness is automatically adjusted by the controller and when cleared the brightness is frozen.

**Note:** *If bit 15 in register 2 is not set (or cleared to zero), this will have no effect.*

**Note:** *When the automatic brightness control bit is cleared, the actual brightness value would be the last value before the operation. If needed, the user can then remotely adjust the brightness value by writing to the corresponding brightness register for the corresponding sensor after enabling the corresponding brightness override register.*

### Sensor 1/Sensor 2 Brightness Override (S1BO and S2BO)

Bit 14 and bit 6 of register 3 allows a remote brightness override functionality. When these bits are set, the user can remotely set the brightness by writing a 6-bit value to the corresponding sensor.

### Sensor 1/Sensor 2 Brightness Override Value

The brightness of Sensor 1 and Sensor 2 can be changed remotely by writing a value between 0 to 64 in these two 6-bit registers. The corresponding brightness override bit has to be set before these values can be accepted by the controller. This advanced feature is typically used by power users with a really good understanding of the brightness control algorithm.

**Note:** *If automatic brightness control is enabled and a remote brightness value is written, then the automatic brightness control algorithm will use that value as the initial value for its algorithm. The final brightness may or may not settle to the override value. This functionality may be useful for some advanced applications.*

## Web guide command register

Bit #	Value	Label	Description
0-7	NA		Reserved for future use
8	0/1	Remote control	0: if cleared to zero, the local operator interface have control over the web guide 1: if set to one, the remote ethernet controller has control over the web guide. The interface icons to control the web guide on the local operator interface will be disabled. Information for monitoring purposes will be displayed on the screen.
9	0/1	Manual/Auto mode	0: if cleared to zero, the web guide will be placed in the manual mode 1: if set to one, the web guide will be placed in the automatic mode
10	0/1	Jog Left or decrease guidepoint	This bit performs two functions based on bit 9. If bit 9 is cleared: <ul style="list-style-type: none"> <li>0: Stop Jog Left operation</li> <li>1: Start Jog Left operation</li> </ul> Note that this register is a write only register and will not change state if the web guide reaches the extreme position. If bit 9 is set: <ul style="list-style-type: none"> <li>0: will clear the register and has no effect</li> <li>1: will decrease the guide point by 0.254 mm or 1/100th of an inch from the current value.</li> </ul> Note that this value on this register is momentary. Before decreasing the guidepoint the bit needs to be cleared before setting it to one. Note that the guide point cannot be at the extremes of the sensing window and will automatically truncate if the extreme limit is reached. The extreme limit depends on the sensor resolution and sensor width.
11	0/1	Jog Right or increase guidepoint	This bit performs two functions based on bit 9. If bit 9 is cleared: <ul style="list-style-type: none"> <li>0: Stop Jog Right operation</li> <li>1: Start Jog Right operation</li> </ul> Note that this register is a write only register and will not change state if the web guide reaches the extreme position. If bit 9 is set: <ul style="list-style-type: none"> <li>0: will clear the register and has no effect</li> <li>1: will increase the guide point by 0.254 mm or 1/100th of an inch from the current value.</li> </ul> Note that this value on this register is momentary. Before increasing the guidepoint the bit needs to be cleared before setting it to one. Note that the guide point cannot be at the extremes of the sensing window and will automatically truncate if the extreme limit is reached. The extreme limit depends on the sensor resolution and sensor width.



12	0/1	Servo Center operation or set guide point	<p>This bit performs two functions based on bit 9.</p> <p>If bit 9 is cleared:</p> <ul style="list-style-type: none"> <li>0: No effect</li> <li>1: Start Servo Center operation</li> </ul> <p>Note that this register is a write only register and will not change state if the web guide reaches the center position. Note that this value on this register is momentary. Before a servo center operation the bit needs to be cleared to zero before setting it to one.</p> <p>If bit 9 is set:</p> <ul style="list-style-type: none"> <li>0: will clear the register and has no effect</li> <li>1: will set the guide point to be at 50% of the sensing window.</li> </ul> <p>Note that this value on this register is momentary. Before decreasing the guidepoint the bit needs to be cleared before setting it to one. The extreme limit is set such that at least ±3.175 mm is available on either side of the adjusted guide point.</p>
13	0/1	Enable arbitrary gross guide point adjustment	<p>This bit allows arbitrary gross adjustment of the guide point offset through the industrial ethernet interface.</p> <p>0: if cleared to zero, gross guide point adjustment is disabled</p> <p>1: if set to one, the remote ethernet controller can make arbitrary gross adjustment to the guide point by writing a 16-bit signed integer to the guide point register.</p>
14-15	NA		Reserved for future

**WARNING:** All the remote control operations may cause the web guide to move without operator intervention. This process may cause process upsets. Caution must be exercised when performing these functions and should be done by those who completely understand the consequence of this change.

**WARNING:** Web Guiding System enabled by SCU5 controller is an automatic control device that may stop and start at any time without notice, especially when controlled remotely. Hence standard safeguards must be in place to prevent any kind of injury.

**WARNING:** The remote control options provide significant access and control of the web guide and the sensor. A combination of the settings may create conditions that might not be ideal for web guiding. Hence only personnel familiar with the web guide operation should program the remote control interface. Contact Roll-2-Roll Technologies' technical support team for any question or assistance.

## Guide point offset register

If the 13th bit of the web guide command register is set, then arbitrary guide point adjustment can be made by writing a 16-bit signed integer value to the guide point offset register. The offset value is the distance from the desired guide point location to the middle of the sensor window. A positive offset value will result in a guide point location towards the right half of the sensor window while a negative offset will result in a guide point location towards the left half of the sensor window. The guide point offset in mm = 0.0635\*(the 16-bit guide point offset register).

## **Actuator speed register**

The positioning speed of the actuator can be changed by setting the 15th bit of the register to 1 and writing a value between 0 and 100 in 7 remaining most significant bits. If the 15th bit is low then the value written in the remaining 7 most significant bits will be ignored.

## **Actuator acceleration register**

The acceleration of the actuator can be changed by setting the 7th bit of the register to 1 and writing a value between 0 and 100 in the 7 least significant bits. If the 7th bit is low then the value written in the register is being ignored.

# COMMISSIONING

## Sensing and Measurement Application

The number of sensors to be connected to the controller depends on the application. The output of the controller should be configured appropriately using the functionality described in the previous section. Once the settings are configured, the user need not interact with the controller at all, except for contrast setup functionality. The screen can be used for monitoring purposes. Please refer to the installation checklist and the sensor installation recommendation documents on the respective sensor product page on the website.

## Web Guiding Application

To ensure optimum performance, a properly installed web guide requires correct threading of the web over the guide rollers and initial positioning of the sensor based on the desired position of the web. Once the material is threaded over the guide rollers and the sensor has been properly positioned, the operator simply needs to press the automatic operation icon on the operator interface. Please refer to the respective sensor and web guide manual for proper installation of the web guiding system.

The following section describes the steps and conditions required for automatic operation with a SCU5 M web guide controller:

1. Ensure that the web guide controller is turned on and that the web is properly threaded over the guide rollers.
2. Press the "Automatic Operation" icon on the operator interface.
3. The web guide controller will automatically adjust the position of the guide rollers to maintain the desired position of the web.
4. The web guide controller will continue to operate in automatic mode until the "Automatic Operation" icon is pressed again.

Please note that the following conditions must be met for automatic operation to be successful:

- The web must be properly threaded over the guide rollers.
- The sensor must be properly positioned based on the desired position of the web.
- The web guide controller must be turned on.
- The "Automatic Operation" icon must be pressed.

## Edge Guiding

1. Power on the system.
2. Set the Automatic/Manual operation to "Manual" (press the Automatic/Manual icon to red).
3. Press the Servo-Center button to center the guide rollers.
4. Thread the material over the rollers. The material wrapped over the rollers must be at a 90 degree

- angle both at the entry and exit of the guide rollers.
5. Verify that the material is aligned in the desired position with respect to the upstream and downstream position of the web. Place the web under normal operation tension.
  6. Adjust the sensor position on the desired edge of the web. Then manually position the sensor so that the edge of the web is at the middle of the sensing window. This can be done by observing the web edge position indicator on the display. When the bar is in the middle position then the web edge is in the middle of the sensing window.
  7. If the sensor position indicator and the actual position of the sensor are different, then press the "Find Sensor" button on the operator interface so that the controller automatically finds the correct orientation of the edge sensor. In order for this function to work, the web edge needs to be in the middle of the sensing window.
  8. Tighten the sensor thumbscrews or the brake on the sensor to secure the sensor position on the sensor rail.
  9. Press the Automatic/Manual operation icon to "Automatic" (press the Automatic/Manual icon to green).
  10. The guide will automatically adjust the position of the web material to guide it to the correct position.

## Center Guiding Application

For center guiding applications, follow the same steps for each sensor before enabling the automatic guiding mode.

### Standard Operating Procedure

The standard operating procedure for the web guide controller involves the following steps:

1. During startup or changeover, servo center the web guide to its home/middle position.
2. Thread the web at the desired location on the web guide rollers.
3. If the guide point offset is not needed, then clear the guide point offset to zero. Otherwise, reset the guide point to the current web location.
4. For edge guiding applications, position the sensor such that the web aligns with the guide point location on the screen.
5. If manual positioning of the sensor is not desired, use the reset guide point operation to digitally move the guide point to the current web position. This is mostly applicable with wide sensors when the new location of the web is still within the sensing window of the sensor.
6. If the web is guided to the center line position, reset the guide point to the current location of the web while ensuring that both edges are seen by the sensors.
7. Set the web guide in automatic mode.
8. If during operation fine adjustments to the guide point are needed, then use the fine guide point adjustment procedure to make the necessary changes while the web guide is in automatic mode. The effect of the guide point adjustment will be seen only when the web is moving.
9. Once the line is stopped for changeover or production stoppage, set the web guide to manual mode



and if needed servo center the web guide to its home/middle position.

## **General Maintenance**

There is no general maintenance required for the web guide controller. Please refer to the respective sensor and web guide manual for maintenance information.

# TECHNICAL SUPPORT AND SERVICE

## Contact information

Roll-2-Roll Technologies LLC is dedicated to providing exceptional service and support to its customers. Please feel free to contact us for any technical support, installation support and service requirements.

Roll-2-Roll Technologies LLC  
1110 S Innovation Way Dr  
Stillwater, OK 74074  
Website: <https://r2r.tech>

Technical Support Phone: +1 (888) 290-3215 - ext 3  
General Support Phone: +1 (888) 290-3125 - ext 1

Technical Support Email: [engineering@r2r.tech](mailto:engineering@r2r.tech)  
General Support Email: [support@r2r.tech](mailto:support@r2r.tech)

## Return shipping instructions

Please contact us to obtain a return merchandise authorization (RMA) number before returning the product to us. If returning the product, please follow the instructions on the RMA form for quick and efficient service.

# REVISION HISTORY

## Hardware Revision

Version	Date	Description
SCU V2	Dec 2014	Initial version with 12 VDC input
SCU V3	Jun 2015	Expanded version with 24 VDC input
SCU V4 Rev B	Oct 2015	Two sensor option, WDT, RTCC
SCU V4 Rev C	Mar 2016	Analog Output
SCU V4 Rev D	July 2016	Industrial ethernet option
SCU5 Rev B	May 2017	Smaller form factor board
SCU5 Rev C	Nov 2017	Robustness improvements
SCU5 Rev D	Dec 2018	Added Digital output option

## Firmware Revision

Version	Date	Description
1.0	Jan 2015	Initial version, single sensor
1.1	Aug 2015	Firmware update for SCU V3, automatic sensor state detection
1.2	Nov 2015	Firmware update for SCU V4 Rev B. Modified sensor algorithm to increase precision and accuracy.
1.3	Dec 2015	Two sensor option with automatic pixel detection
1.4	Mar 2016	Background suppression algorithm
1.5	Apr 2016	Analog output
2.1a	Aug 2016	Firmware update for SUC V4 Rev D
2.2b	Dec 2016	Ethernet/IP implicit messaging, edge detection algorithm updates
2.4a	Jun 2017	Changes to guide point adjustment and Ethernet/IP registers
2.5	Apr 2018	Minor bug fixes, enabled password protected screen
2.6	Nov 2018	Provided more access to internal settings of the controller for power users.
3.3	Dec 2018	Updated functionality to version 3 algorithm.
3.3c	Jan 2019	Updated functionality to include minimum contrast setting.
3.3d	Jun 2019	Added functionality for both static and dynamic thresholding.
3.4	Jul 2019	Significant update with added functionality for power user access and for built in width measurement application.
3.4a	Aug 2019	Added the ability to view and change the ethernet network settings from the SCU5 controller communication screen.
3.4b	Mar 2020	Improvements to edge detection algorithms and improved processing speed.
3.5b	Oct 2020	Added support for 2x WPS 440 with digital I/O
3.6a	Aug 2021	Added support for ODC 48, 96, 192, 384
3.6b	Nov 2021	Added support for Hilscher module
3.6c	Nov 2021	Added support for ODC 768





**Roll-2-Roll Technologies LLC**  
1110 S Innovation Way Dr  
Stillwater, OK 74074  
[www.r2r-tech.com](http://www.r2r-tech.com)  
[info@r2r-tech.com](mailto:info@r2r-tech.com)  
+1-(888)-290-3215