

SCU5 Controller

Installation, Operation and User Manual



Roll-2-Roll Technologies LLC

✉: 1110 S Innovation Way
Stillwater, OK 74074
United States

☎: +1-888-290-3215

✉: experts@r2r.tech

🌐: <https://r2r.tech>

SCU5 Controller

Installation, Operation and User Manual

KEYWORDS:

Web Guiding
Edge Guiding
Line Guiding
Contrast Guiding
Master/Slave Guiding
Chase/Follow Guiding
Web Guide Oscillation
Width Measurement
Web Monitoring
Flag Detection
Thread Counting
Strip Width Measurement
Ribbon Detection
Tear Detection
Web Inspection

FIRMWARE

v3.6n+

DOCUMENT DATE

Feb 27, 2024

DOCUMENT TYPE

Manual

NUMBER OF PAGES

125

ABSTRACT

This is the user manual for SCU5 controller. This manual is intended for operators (use), maintenance professionals (installation and troubleshooting) and engineers (machine design and installation).

Copyright Information

All of the information herein is the exclusive proprietary property of Roll-2-Roll Technologies LLC, and is disclosed with the understanding that it will be retained in confidence and will neither be duplicated or copied in whole or in part nor be used for any purpose other than for which it is disclosed.

Information in this document is believed to be reliable and accurate. However no responsibility is assumed as a result of its use nor for any inaccuracies, infringement of patent or other rights of third parties resulting from its use.

The information in this document is subject to change without any notice.

Copyright © 2024 Roll-2-Roll Technologies LLC

Contents

1	About the Document	6
2	Safety Instruction	7
2.1	Instructions for Installation and Commissioning	7
2.2	Instructions for Use	7
2.3	Proper Use	7
2.4	Improper Use	8
2.5	Static Discharge and Grounding	8
3	Introduction to the Controller	9
3.1	Measurement, Sensing and Monitoring Applications	10
3.2	Web Guiding Application	10
4	Electrical and Mechanical Interfacing	12
4.1	Controller Specification and Options	12
4.2	Physical Dimensions	13
4.2.1	Mounting location	13
4.2.2	Mounting Option	14
4.3	Touchscreen Operator Interface	14
4.4	Connectors	14
4.4.1	Power Input (Port 1)	14
4.4.2	Sensor Ports	16
4.4.3	Motor Communication (Port 2)	17
4.4.4	Opto-Isolated Input (Port 2)	17
4.4.5	Analog Output (Port 2)	18
4.4.6	Industrial Ethernet (Port 3)	19
4.4.7	Opto-Isolated Output (Port 3)	20
4.4.8	Dry Contact Input (Port 3)	21
4.4.9	Dry Contact Input + Opto-Isolated Output (Port 3)	23
5	Operator Interface	26
5.1	Home/Main Screen	26
5.1.1	Heartbeat Indicator	27
5.1.2	Web Detect Indicator	27
5.1.3	Web Position Bar	28
5.1.4	Sensor Orientation Indicator	33
5.1.5	Zoom Indicator	33
5.1.6	Actuator Position Bar	34
5.1.7	Find Edge Button	35
5.1.8	Auto/Manual Button	37
5.1.9	Servo Center	38
5.1.10	Jog Left/Jog Right Icon	40
5.1.11	Guide point Indicator	41

5.1.12	Guide Point Offset Value	42
5.1.13	Gross Guide Point Adjustment	42
5.1.14	Reset Guide Point	44
5.1.15	Fine Guide Point Adjustment	45
5.1.16	Firmware Version	48
5.1.17	Actuator Icon	48
5.1.18	Tools Icon	48
5.2	Operator: Actuator Position Screen	49
5.2.1	Actuator Position Bar	49
5.2.2	Jog Left/Jog Right Icon	49
5.2.3	Reset Servo Center Position	50
5.3	Advanced Settings Menu	52
5.4	Operator Menu	55
5.5	Operator: Sensor Screen	56
5.5.1	Sensor Mode	56
5.5.2	Thresholding Mode	58
5.5.3	Sensor Selection	59
5.5.4	Minimum Contrast Gauge	59
5.5.5	Brightness Gauge	60
5.5.6	Brightness Control	60
5.5.7	Live Processed Image Preview	60
5.5.8	Feature Navigation Left/Right	61
5.5.9	Selected Feature	61
5.5.10	Teaching	61
5.5.11	Contrast Type	62
5.5.12	Scroll Window Left/Right	66
5.5.13	Scroll Window Region	66
5.5.14	Zoom State	67
5.6	Operator: Width Screen	69
5.6.1	Nominal Width	70
5.6.2	Upper Limit	70
5.6.3	Lower Limit	71
5.6.4	Measured Width	71
5.6.5	Teaching	72
5.6.6	Output Type	73
5.7	Operator: Display Screen	75
5.8	Operator: Contact Screen	76
5.9	Operator: Oscillation Screen	77
5.9.1	Oscillation ON/OFF	77
5.9.2	Oscillation Amplitude	78
5.9.3	Oscillation Speed	78
5.9.4	Oscillation Dwell Time	78
5.9.5	Oscillation Type	78
5.10	Operator: Flag Detection Screen	80
5.10.1	Flag Detection Enable/Disable Button	81
5.10.2	Flag Detected Signal	81

5.10.3	Flag Detected Setup	81
5.11	Operator: Flag Detection Setup Screen	82
5.11.1	Minimum Flag Length	82
5.11.2	Reset Duration	83
5.11.3	Output Hold Duration	83
5.11.4	Sensor Selection	84
5.12	Power User Menu	85
5.13	Power User: Actuator Screen	86
5.13.1	Actuator Stroke (Digital)	86
5.13.2	Actuator Pitch (Digital)	87
5.13.3	Motor Polarity	88
5.13.4	Servo Center Polarity	88
5.13.5	Actuator Speed	89
5.13.6	Actuator Acceleration	90
5.14	Power User: Sensor Screen	91
5.14.1	Enable/Disable Sensor Button	91
5.14.2	Sensor Orientation Buttons	92
5.14.3	Sensor Type Selection Button	95
5.14.4	Brightness Gauge	95
5.14.5	Brightness Control	95
5.15	Power User: Controller Screen	97
5.15.1	Controller Gain Gauge	98
5.15.2	Deadband Gauge	98
5.15.3	Reverse Error Polarity	98
5.15.4	Lock on Lost Edge Button	99
5.15.5	Servo Center Sensor Enable Button	99
5.15.6	Limit Switches Enable Button	100
5.16	Power User: Master Slave Setup Screen	101
5.16.1	Master/Slave Enable Button	102
5.16.2	Master/Slave Sensor Selection Button	103
5.16.3	Master/Slave Polarity Button	103
5.17	Power User: Analog Output Screen	104
5.17.1	Analog Mode Selection	105
5.17.2	Analog Voltage and Current Selection	111
5.17.3	Analog Output Polarity	112
5.17.4	Analog Setup Selection	112
5.18	Power User: Password Screen	113
5.19	Power User: Communication Screen	114
5.19.1	Ethernet Status	114
5.19.2	DHCP Status/Selection	114
5.19.3	FTP Status/Selection	115
5.19.4	Ethernet Module Type	116
5.19.5	Industrial Ethernet Protocol Type	116
5.19.6	IP Address Value	116
5.19.7	Subnet Mask Value	117
5.19.8	Gateway Value	117

5.19.9	Mac Address	117
5.19.10	IP Address Change Button	118
5.19.11	Subnet Mask Change Button	118
5.19.12	Gateway Change Button	119
6	Commissioning	120
6.1	Sensing and Measurement Applications	120
6.2	Web Guiding Applications	120
7	Technical Support and Service	123
7.1	Contact information	123
7.2	Return shipping instructions	123

1. About the Document

This manual provides detailed instructions on how to install, commission, operate, maintain, and troubleshoot the SCU5 controller part of the Roll-2-Roll® Controller family. It is essential for all individuals engaged in the design, installation, commissioning, operation, maintenance, and troubleshooting of the controller to carefully review this document. The manual outlines the features and correct utilization of the controller, emphasizing the importance of having both a physical and digital copy of the manual readily available for individuals working with or installing the controller. By thoroughly reviewing this manual, users will develop a comprehensive understanding of how to effectively utilize the controller.

Throughout this document, relevant supplementary details are presented, with particular emphasis as specified below.

Warning

It is crucial to carefully read all the information in this warning section. Neglecting to do so could lead to harm or damage to the system, equipment, and personnel. These sections should not be disregarded, and any misuse of the product in defiance of the warnings given will invalidate any warranty.

Note

It is important to thoroughly review all the information in this note section. The content here aims to outline normal operations or alternative methods to achieve a specific function.

Info

Additional supplementary information, aimed at providing detailed explanations of certain concepts, is included in this info section. It is essential to read and comprehend the information provided in this section. be helpful for overall understanding and troubleshooting purposes.

The guidance provided in this document is relevant solely to the SCU5 controller. Before proceeding with the installation or activation of the SCU5 controller, it is advisable to review any additional materials concerning Roll-2-Roll® Sensors, Roll-2-Roll® Drivers, Roll-2-Roll® Web Guides, Roll-2-Roll® Actuators, and other relevant details. This should also include any custom adjustments that may be provided for specific customers.

2. Safety Instruction

The SCU5 controller is an electrical device that operates at a low voltage (24 VDC \pm 5%). However, it does present certain safety requirements that must be strictly adhered to to ensure the safe and effective operation of the system.

2.1 Instructions for Installation and Commissioning

The SCU5 controller must be properly transported and stored before being professionally installed. The controller should not be installed or commissioned for operation if discernible damage is observed. Only qualified individuals should perform the installation, commissioning, operation and maintenance of the system.

Warning

- *Never install or use a controller that appears damaged.*
- *Any installation work around a web guide or the machine should be done with the power to the controller turned off.*
- *Adhere to appropriate lockout/tagout procedures while commissioning the Roll-2-Roll® Controller.*
- *Never use cables that appear to be damaged.*
- *Always connect all cables before turning on the power to the controller.*
- *Please read this product manual thoroughly before installation and commissioning.*

2.2 Instructions for Use

Any personnel tasked with operating the controller should familiarize themselves with the general functional principles of the system.

Note

- *Please read this product manual thoroughly and follow its instructions.*
- *Please read and adhere to the warning labels that are affixed to the device.*
- *Be aware of all applicable national, state and local requirements for accident prevention and environmental protection.*

2.3 Proper Use

The controller is designed exclusively for indoor use. It can be integrated into industrial and laboratory equipment that processes materials in the web form or any material moving on a conveyor. The controller finds application in the following areas:

- Web guiding (edge, center, contrast, line, etc.)

- Web position measurement (edge position monitoring, width measurement, contrast position monitoring, etc.)
- Web inspection application (contrast width measurement, tear detection, flag detection, registration mark detection, etc.).

The controller is designed for application in machinery that processes continuous materials. Any implementation beyond the aforementioned parameters should be referred to Roll-2-Roll Technologies for endorsement.

2.4 Improper Use

Any use of the equipment that falls outside of the following guidelines shall be considered improper use and voids any warranty of the equipment:

Warning

- *Outdoor use or exposure to direct sunlight*
- *Any modifications made without Roll-2-Roll Technologies' consent*
- *Any use of accessories not approved or recommended by Roll-2-Roll Technologies*
- *Any use outside the general specifications*

2.5 Static Discharge and Grounding

Webs, particularly plastic webs, can generate a significant static voltage potential when transported over rollers. This static voltage may be discharged to the controller via the sensor cables. Proper grounding of the controller is necessary to safely dissipate the static potential.

Note

- *Proper grounding can be verified by checking the continuity between any of the controller's connectors and the earth ground.*
- *Avoid creating ground loops when grounding.*

3. Introduction to the Controller

The SCU5 controller serves as the central processing unit for Roll-2-Roll Technologies' products. Each system incorporates a Roll-2-Roll® Controller responsible for capturing and processing images from Roll-2-Roll® Sensors. Essentially, the controller exerts comprehensive control over the sensor hardware through the sensor cable. It dictates image capture conditions such as lighting brightness, image capture timing, and image exposure.

The controller receives the raw image captured by the sensor. The image is then processed using digital signal processing algorithms. Subsequently, the processed image is utilized to provide outputs for downstream applications.

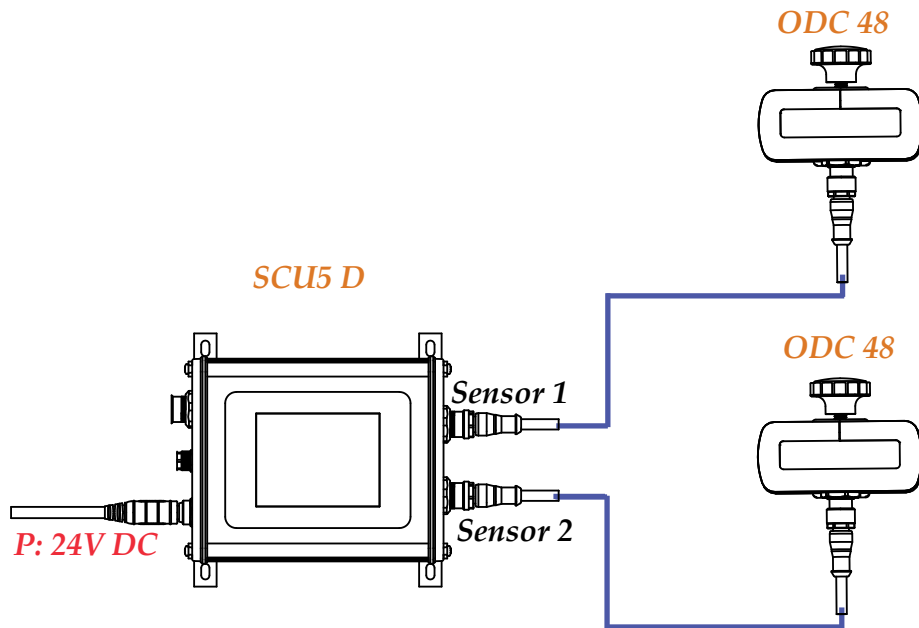


Figure 3.1: SCU5 Controller with two Roll-2-Roll® Sensors

The SCU5 controller includes a color touchscreen operator interface, which enhances human-machine communication. This user-friendly interface enables quick adjustments to controller settings, streamlining the setup, maintenance, and operational procedures. In addition, operators can effectively manage their daily activities using just one or two interface screens or pages, thereby boosting productivity.

The SCU5 controller is used primarily to monitor the cross-machine position of dynamic materials such as webs. This is accomplished by identifying the edges within the captured images. The edge detection process includes the detection of both the edges of the web and the contrasting edges present in the web material. As a result, SCU5 controller is suitable for use in measurement and detection tasks, as well as in guiding web materials. Depending on the specific needs, either of two sensors may be employed for an application. Additionally, each controller can manage one web guide, which is determined by the web position data obtained from one or two Roll-2-Roll® Sensors.

3.1 Measurement, Sensing and Monitoring Applications

A primary benefit of Roll-2-Roll® Controllers is their simplicity. Programming is not required to implement 1D inspection applications. For most applications, users do not have to alter any settings, even if the material characteristics vary. Only a handful of parameters need to be tweaked in complex applications. Moreover, in scenarios with contrasting features, setting up the controller to monitor a web feature is as simple as pressing a few buttons on its interface. An operator can accomplish this with minimal training, eliminating the need for a specialized engineer.

Unlike traditional sensors, edge detection is performed using advanced digital signal processing algorithms to analyze the 1D image from the Roll-2-Roll® Sensors. These algorithms can automatically adjust to the following:

- Scattering properties of the web material
- Distance (to some extent) of the web material from the sensor
- Loss of focus or blurred image capture

Due to these advantages of the edge detection algorithm, the controller does not have spatial ambiguity and provides an absolute web position measurement. Additionally, the controller can detect multiple edges simultaneously, with the limit on the number of edges essentially determined by the firmware used. These benefits allow the algorithm to be used not only for sensing applications (such as edge sensing) but also for measurement applications (such as width measurement) and monitoring applications (such as thread counting).

Measurement, sensing, and monitoring applications enabled by the advanced digital signal processing algorithms include: web edge position measurement, line/contrast position measurement, width measurement, mark detection, flag detection, tear detection, multiple strip width measurement, multiple strip gap measurement, thread/string detection and counting, and more.

The Roll-2-Roll® controller offers different outputs tailored to the application needs. For enhanced automation with PLCs, Ethernet-based industrial fieldbus communication options are the preferred choice. Discrete digital inputs and outputs can be utilized via digital input-output (I/O) options. SCU5 controller also has the ability to provide current and voltage output through the analog output feature. To facilitate integration with legacy systems and PLCs, predefined output ranges are provided.

3.2 Web Guiding Application

A web guiding application extends the capabilities of the web position measurement application. After measuring the position of the web (edge, line, or position of a contrast feature), the controller implements corrective actions to align the web material to the desired position within the machine. In this scenario, the SCU5 controller functions as a closed-loop controller for the web guiding system.

Figure 3.2 displays the control setup for the Roll-2-Roll® Controller integrated with an Roll-2-Roll® Sensor. After the SCU5 controller analyzes the image from the sensor(s), it calculates the necessary adjustments by comparing the actual and target positions of the web (guide point). The SCU5 controller works with any web guide system, regardless of size, when paired with the right Roll-2-Roll® Driver and Roll-2-Roll® Actuator. In contrast to conventional controllers that use velocity-based systems, Roll-2-Roll® Controllers determine the positional adjustments and relay these data to the Roll-2-Roll® Driver. Commands for positioning from the SCU5 controller are

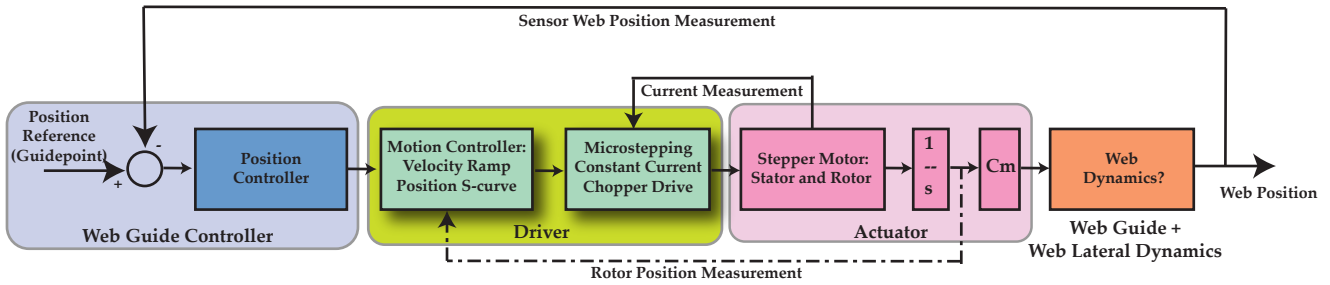


Figure 3.2: Control structure for Roll-2-Roll[®] Controllers for web guiding applications

directed to a chosen Roll-2-Roll[®] Driver, depending on the Roll-2-Roll[®] Actuator's size. The driver adheres to sophisticated motion patterns to meet the position command with a specific velocity and position profile, ensuring a robust closed-loop control system. The Roll-2-Roll[®] Driver employs sophisticated current control with a 256 microstep resolution to achieve the most fluid motion and optimal current efficiency. Ultimately, the web guide system, linked to the actuator, modifies the web according to the corrective measures, establishing a comprehensive closed-loop web guiding system.

Parameters such as actuator stroke length, actuator gear ratio, maximum correction speed, maximum correction acceleration, and maximum actuator current can be configured on SCU5 controller. Additionally, closed-loop controller parameters like gain, guide point offset, deadband, error polarity, actuator polarity, actuator limits, and others can also be set on the SCU5 controller. Lastly, the SCU5 controller supports various guiding applications, including single-edge guiding, center guiding, line guiding, contrast/pattern guiding, master-slave guiding, and web oscillations.

Refer to the specific product documentation for installing the Roll-2-Roll[®] Sensors, Roll-2-Roll[®] Actuators, and Roll-2-Roll[®] Web Guides.

4. Electrical and Mechanical Interfacing

This section presents the electrical and mechanical specifications for the installation, wiring and integration of the SCU5 controller into the roll-to-roll processing machinery.

4.1 Controller Specification and Options

Contingent upon the application, one or more of the options would be accessible. All options for the Roll-2-Roll® controller encompass a built-in color touchscreen operator interface.

General Specifications			
Input Supply	24V ± 5%	Current Requirement	3 - 5 Amps
Display Mode	TFT - Color	Operator Interface	Touchscreen
Analog Output (Voltage)	0 - 5V 0 - 10 V ±5 V ±10 V	Analog Output (Current)	0 - 10 mA 0 - 20 mA 0 - 24 mA 4 - 20 mA
Fieldbus Options	EtherNet/IP PROFINET EtherCAT Modbus/TCP CC-Link IE FB	Digital I/O Options	2x Output NPN 4x Input Dry Contact
Web Guide Loop	5ms - 40 ms	Image Processing Loop	1.34 ms - 40 ms

The subsequent table provides a detailed specification of SCU5 controller options, including their corresponding ordering data.

Product Codes and Ordering Information			
Application	Product Name	SKU	Option
Sensing	SCU5 D+	4-100221	Analog Output
	SCU5 DIO	4-105221	4x Dry Contact and 3x Output NPN
	SCU5 C(E)D	4-100211	EtherNet/IP
	SCU5 C(E)D+	4-100241	EtherNet/IP + Analog Output
	SCU5 C(P)D	4-101211	PROFINET
	SCU5 C(P)D+	4-101241	PROFINET + Analog Output
	SCU5 C(M)D	4-102211	Modbus/TCP
	SCU5 C(EC)D	4-106211	EtherCAT
Web Guiding	SCU5 MD	4-100121	Standard Motor Communication (M)
	SCU5 MDIO	4-105221	M + 4x Dry Contact Input + 2x NPN Output
	SCU5 MC(E)D	4-100111	M + EtherNet/IP
	SCU5 MC(P)D	4-101111	M + PROFINET
	SCU5 MC(M)D	4-102111	M + Modbus/TCP
	SCU5 MC(EC)D	4-106111	M + EtherCAT

4.2 Physical Dimensions

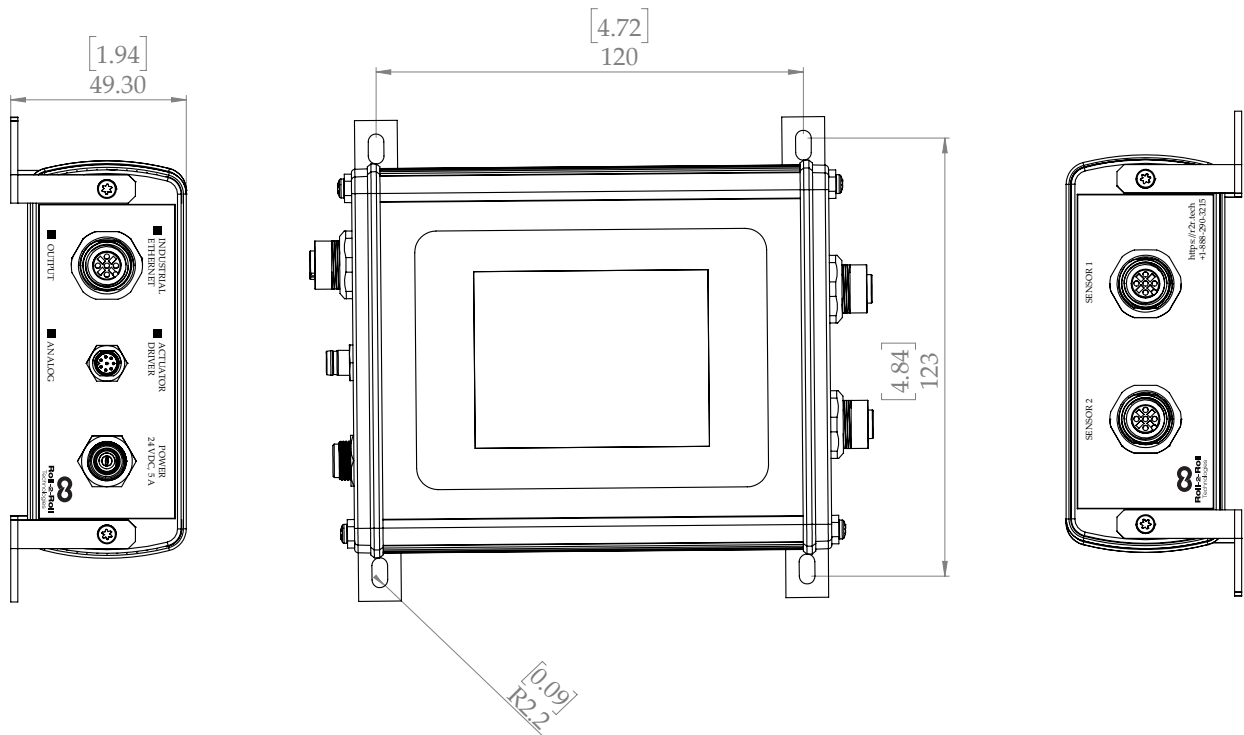


Figure 4.1: SCU5 controller Physical Dimensions (All dimensions are in mm [in]); Subject to change without notice.

4.2.1 Mounting location

SCU5 controller must be installed on a flat machine surface or on a wall, preferably at the eye level for ergonomic operator interaction. The machine surface should be stable without vibrations or the controller should be protected from vibrations. Ideally the location should be in such a way that the operator can see the SCU5 controller as well as the sensor or the web guiding system being controller.

The controller may not be installed in a location that might be too hot and should never be installed in a location that has a risk of explosion. Ideally, the controller should be accessible to the operator and outside light curtain or safety barriers.

Warning

Do not place the SCU5 controller near high magnetic fields.

4.2.2 Mounting Option

The wall-mounting brackets can be utilized to mount SCU5 controller. Fasteners with thread sizes of M4, 6-32, or 8-32 may be used to securely mount the SCU5 controller to the mounting surface.

Note

The controller does not include a dedicated ground pin; nonetheless, ring terminals can be used to connect the enclosure body to the protective earth using the screws on the wall mounting bracket. This helps reduce electrical interference near the controller, mainly for operational purposes rather than safety.

4.3 Touchscreen Operator Interface

The SCU5 controller is equipped with a 3.2" wide (diagonal) color touchscreen that utilizes capacitive touch functionality. The screen can be operated using fingers, conductive gloves, or a capacitive touch-capable stylus.

Note

The screen on the SCU5 controller may become warm when the display brightness is set to 100%.

Warning

Refrain from using sharp or pointed tools of any kind to operate the touchscreen, as this can damage the protective glass cover bezel.

4.4 Connectors

Depending on the type of controller, four or five connectors are available on the SCU5 controller.

Note

For certain customized controllers, one of the sensor ports may be disabled to facilitate high-speed image processing.

4.4.1 Power Input (Port 1)

Port 1 serves as the power input for the SCU5 controller, operating with 24 VDC ($\pm 5\%$) power and a maximum current requirement of 5 amps. The power is supplied via a Switchcraft DC power connector.

Warning

- Supplying more than 24 VDC can cause permanent damage to the controller.*
- A reverse polarity connection can also result in permanent damage to the controller.*
- Please take all possible measures to ensure proper grounding of the controller. Inadequate*

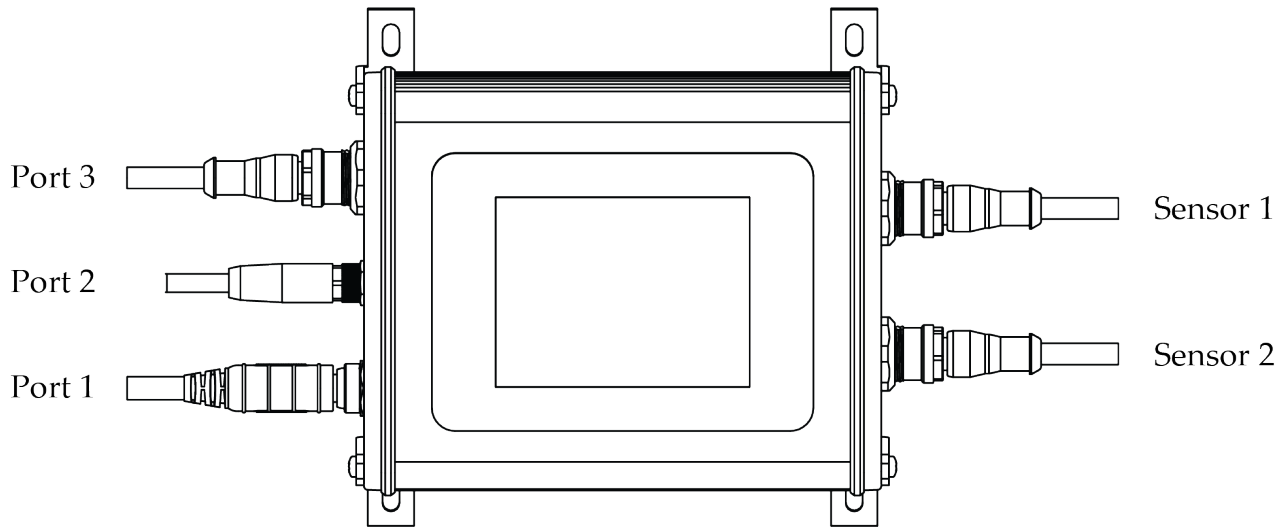


Figure 4.2: SCU5 controller Connector and Port Labels

grounding may lead to static build-up, potentially causing controller malfunctions.

Switchcraft DC Connector

The power jack port on the SCU5 is a **Switchcraft L712AS** power jack port. A mating **Switchcraft 761KS12** sealed plug connector or a pre-assembled Switchcraft **CARA761KS07984** or **CA761KS07984** can be used to supply power. For the plug connector, the 24 VDC power should be connected to the tip/center pin, and the power ground should be connected to the sleeve pin.

A pre-made **24 V DC Input Power Cable**, which features a plug connector on one end and flying leads on the other end, is also available for purchase from Roll-2-Roll Technologies. The polarity on the flying lead is red (24 VDC) and black (power ground).

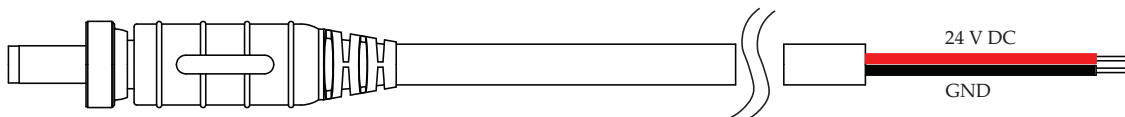


Figure 4.3: Power Input Cable Wiring Information

Industrial Din Rail Power Supply

Industrial DIN rail mountable power supplies, such as the Mean Well **SDR-75-24** or **SDR-120-24**, can be utilized to provide 24VDC power. These power supplies are available for purchase from Roll-2-Roll Technologies.

4.4.2 Sensor Ports

Two sensor ports, labeled "Sensor 1" and "Sensor 2," are equipped with industry standard 12-pin M12 A-coded connectors, designed to connect the 12-pin connector on the sensor cable. Either sensor port can be used to establish the sensor connection and the controller will automatically recognize it.

Note

There is no need to shut off the controller prior to plugging in or unplugging the sensor cables, but it is advisable.

Warning

The connectors are keyed, and excessive force should not be applied when connecting them. Doing so may damage the pins and potentially harm the sensor and/or controller ports.

Sensor Cable Recommendations

Industry-standard 12-pin M12 A-coded cordsets are suitable for use, provided that the cable is shielded and the shield is properly connected to the coupling nut as shown in Figure 4.4. Individual conductors are also recommended to have a wire gauge of at least 26 AWG, preferably 24 AWG. The use of twisted pairs is not recommended.

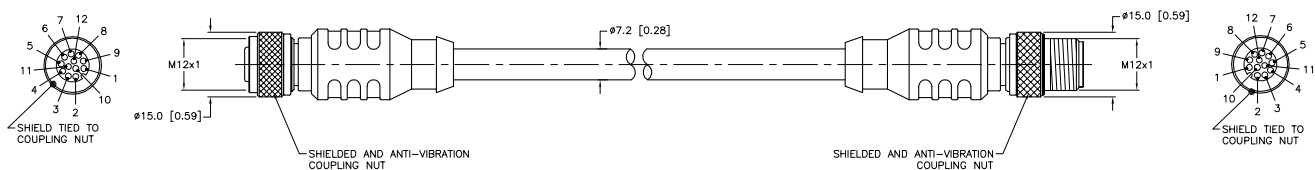


Figure 4.4: Quick Disconnect Sensor Cable

Roll-2-Roll Technologies maintains an inventory of **Quick Disconnect Sensor Cable 3m and 5m** manufactured by **Turck**. The following is a list of suggested manufacturers and their respective cable part numbers in order of preference.

1. Turck: **RKS 12T-x-RSS 12T** (x is the cable length in meters)
2. Turck: **WKS 12T-x-RSS 12T** (x is the cable length in meters)
3. Murr: **7000-53301-7060500** (5m long)
4. Phoenix Contact: **SAC-12P-MS/ 3,0-35T/FS SH SCO** (3m long)

Note

- *Turck cables are recommended, and cables up to 10 meters in length may be utilized.*
- *Murr cables exceeding 5 meters in length are not advised.*
- *Phoenix Contact cables greater than 3 meters in length are not recommended.*
- *Before adding any patch cords, please consult with the factory.*

Warning

Only the sensors and cables supplied or endorsed by Roll-2-Roll Technologies LLC should be connected to the sensor ports. Using any other cable may not yield the intended performance.

4.4.3 Motor Communication (Port 2)

The SCU5 controller with the suffix "M," which is utilized in web guiding applications, is equipped with a 4-pin Male M8 connector situated on port 2. This connector facilitates communication between the controller and a Roll-2-Roll® Driver. A pre-wired **motor communication cable**, featuring 4-pin M8


Male	Pin	Color	Signal
	1	Brown	+24V
	2	White	RS 485 B-
	3	Blue	RS 485 A+
	4	Black	GND

Table 4.1: Signal and Pin Number for M8 Motor Communication

female connectors at both ends, is employed to establish a connection between the SCU5 controller and a Roll-2-Roll® Driver. This cable transmits both power and communication signals between the SCU5 M controller and the Roll-2-Roll® Driver.

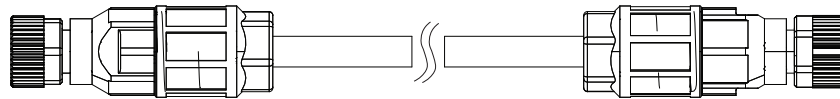


Figure 4.5: Quick disconnect motor communication cable

Note

It is imperative that only cables supplied by Roll-2-Roll Technologies LLC are connected to the motor communication port.

Warning

Under no circumstances should the motor communication cable be connected or disconnected while the SCU5 controller is powered on. Always ensure that the SCU5 controller is powered off during the connection or disconnection of the motor communication cable.

4.4.4 Opto-Isolated Input (Port 2)

The SCU5 controller utilized for sensing applications that incorporate a digital input option (SCU5 DIO) is equipped with a 4-pin Male M8 connector on port 2. This enables the controller to accept two independent external digital inputs (12 - 24 VDC) for triggering and synchronization purposes. The pin-outs for the connector are illustrated below.


Male		Pin	Color	Signal
		1	Brown	NC
		2	White	IN 1
		3	Blue	GND
		4	Black	IN 2

Table 4.2: Signal and Pin Number for M8 Digital Input

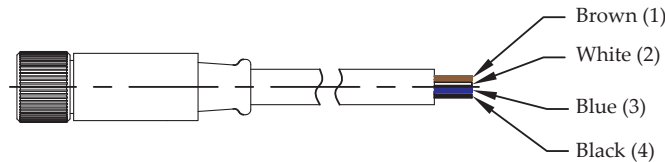


Figure 4.6: Digital input cable signal information

Info

These are application-specific inputs that are not standard. For more information, please refer to the relevant application-specific documentation.

4.4.5 Analog Output (Port 2)

SCU5 controller that incorporate analog output functionality are equipped with a 3-pin Male M8 connector for analog output. Both voltage and current outputs are accessible from this connector, which also features a common ground pin. The pin-outs are illustrated below.

Male		Pin	Color	Signal
		1	Brown	Voltage
		3	Blue	Current
		4	Black	GND

Table 4.3: Signal and Pin Number for M8 Analog Output

Warning

These pins are isolated outputs. Refrain from connecting a power source to them. Certain analog input cards on PLCs may be equipped with a voltage source to power sensors. Please refrain from connecting the voltage source to these pins, as it could result in permanent damage to the controller.

Info

Available voltage ranges are as follows: 0 - 5 V, 0 - 10 V, ± 5 V and ± 10 V. Available current ranges are as follows: 0 - 10 mA, 0 - 20 mA, 0 - 24 mA and 4 - 20 mA. These output options can be configured on the SCU5 controller through the analog setup screen referenced in Section 5.17.

Industry standard M8 3-pin analog output cable are available for purchase from Roll-2-Roll Technologies. Standard cable lengths are 3 m and 5 m. Analog output cables that can connect to legacy controllers from other manufacturers are also available. Contact us for more information.

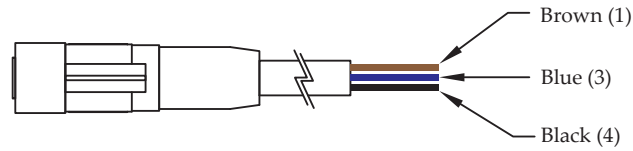


Figure 4.7: Analog output cable signal information

4.4.6 Industrial Ethernet (Port 3)

Industrial Ethernet is available on SCU5 controller that incorporate one of the standard industrial Ethernet protocols, such as EtherNet/IP, PROFINET, EtherCAT, or Modbus/TCP. Communication with the SCU5 controller is possible using an external PLC or computer.

Industrial Ethernet Cable Recommendations

An industry-standard 4-pin D-coded M12 female socket connector is provided for this connection on Port 3. Standard M12 4-pin D-coded male to RJ45 shielded Ethernet cables can be used to connect the SCU5 controller to an Ethernet network.

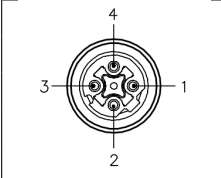
	Pin	Color	Signal
	1	White/Orange	TD+
	2	White/Green	RD+
	3	Orange	TD-
	4	Green	RD-

Table 4.4: Signal and Pin Number for M12 4-pin D-coded Ethernet

Roll-2-Roll Technologies stocks and sells **3m long M12 4-pin D-coded ethernet cables with RJ45 connector** manufactured by **Murr Elektronik**.

Here is a list suggested manufacturers and their respective cable part numbers.

1. Murr: **7700-44711-S4U0500** (5m)
2. Murr: **7700-44711-S4U1000** (10m)
3. Turck: **RSS RJ45S 441-xM** (x is the cable length in meters)
4. Phoenix Contact: **NBC-MSD/ 5,0-93E/R4AC SCO** (5m long)

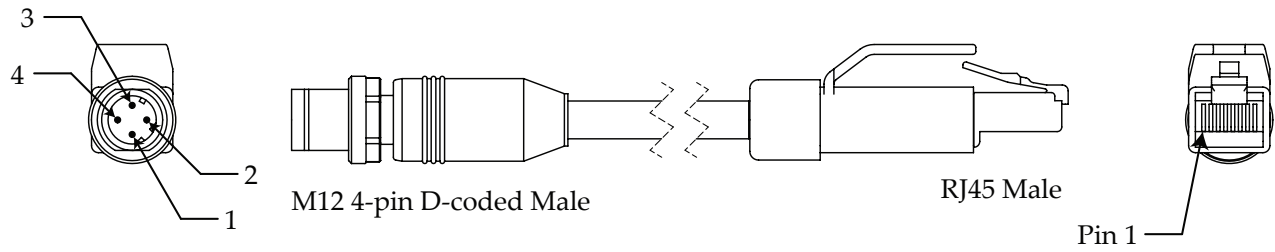


Figure 4.8: M12 to RJ45 cable information

4.4.7 Opto-Isolated Output (Port 3)

In certain applications, it is possible to provide two digital outputs from the SCU5 controller for alarm and notification purposes. Examples of such applications include alarms for width measurement, contrast guiding, and other inspection applications such as flag detection and thread counting.

With this option, two optically-isolated NPN type outputs are accessible on Port 3. A standard M12 4-pin A-coded female connector is provided with the following pin assignment:

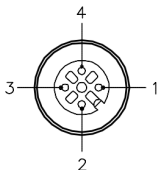
	Pin	Color	Signal
	1	Brown	VDD
	2	White	OUT 2
	3	Blue	GND
	4	Black	OUT 1

Table 4.5: Signal and Pin Number for M12 4-pin Digital Output

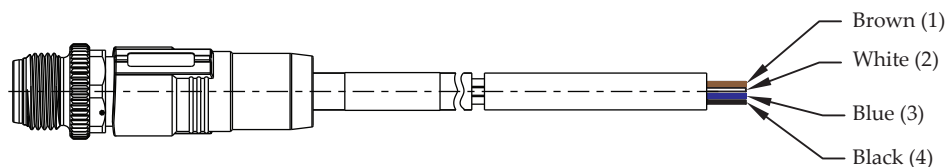


Figure 4.9: M12 4-pin digital IO cable information

The outputs can be utilized as NPN normally closed outputs by supplying a VDD (12 - 24 VDC) and GND from a PLC; the output signals are available on OUT1 and OUT2. A typical circuit for the output is illustrated below:

Note

The outputs are normally closed. When wiring a relay, connect to the NC side of the circuit so that the appropriate output from the relay is provided to the device.

If the SCU5 controller requires integration with a PLC with PNP inputs, relays can be employed to achieve this, as depicted in the following wiring diagram:

NPN Normally Closed Output

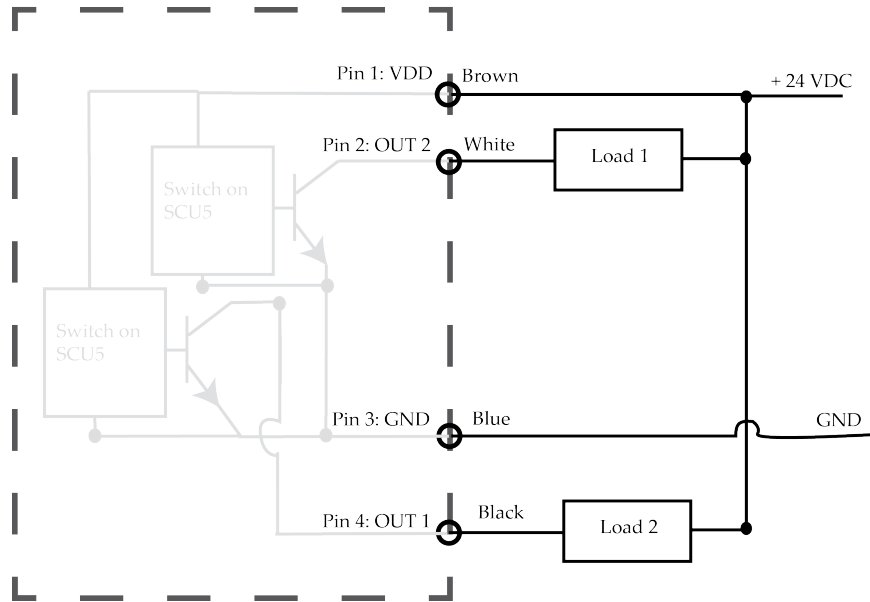


Figure 4.10: Typical wiring information for NPN normally closed output from SCU5 Controller

Info

The availability of this digital output option is limited to legacy SCU5 hardware configurations. For new applications, it is recommended to utilize the DIO option.

4.4.8 Dry Contact Input (Port 3)

The SCU5 controller, equipped with the web guiding option (SCU5 MDI), additionally accommodates two straightforward dry contact inputs intended for remote control purposes on Port 3. A standard M12 4-pin A-coded female connector is provided with the following pin assignment: The same M12 4-pin

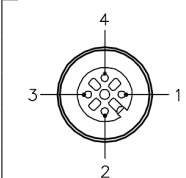
	Pin	Color	Signal
	1	Brown	NC
	2	White	IN 1
	3	Blue	CGND
	4	Black	IN 2

Table 4.6: Signal and Pin Number for M12 4-pin Dry Contact Input Option

digital IO cable as in 4.9 can be used for wiring to the inputs.

The dry contact input can be established by the end user through the utilization of either a physical or electronic switch, accomplished by linking (or shorting) the inputs to the shared ground signal (CGND). A typical circuit for the input is illustrated below:

These inputs serve the purpose of facilitating basic automation or coordination between the web

NPN Normally Closed Output with Relay

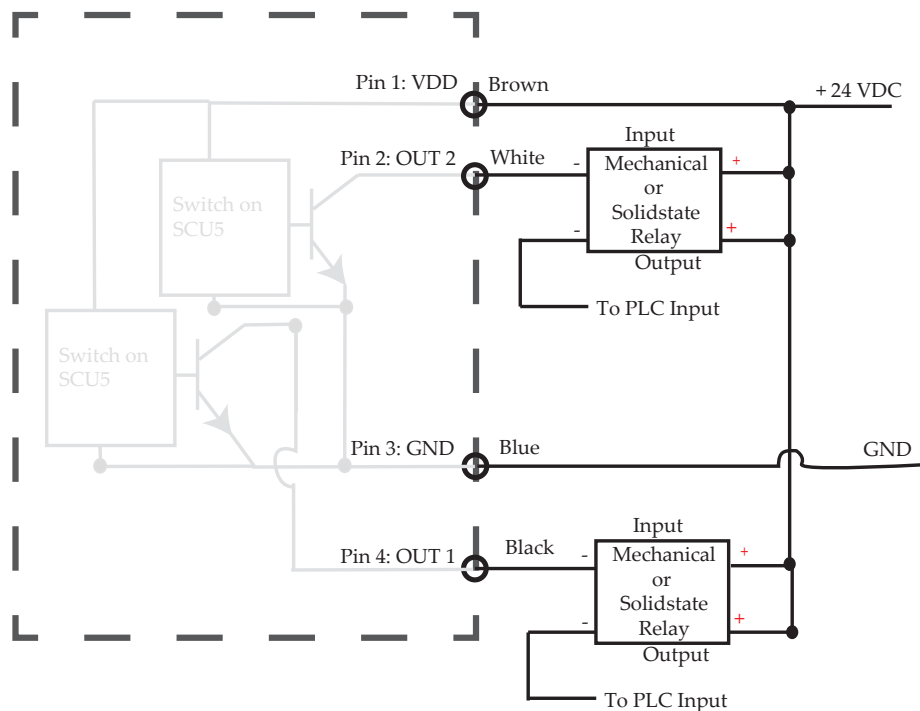


Figure 4.11: Typical wiring information for NPN normally closed output from SCU5 Controller to PNP inputs in a PLC

M12 4-pin Female Connector

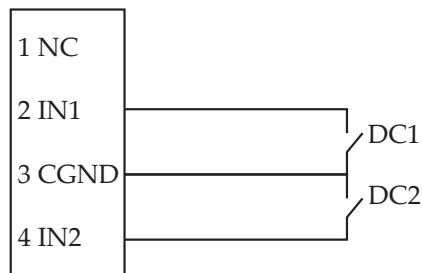


Figure 4.12: Typical wiring information for dry contact inputs

guide and the overarching machine. They can be employed to lock the web guide to its current position based on the signal from the line speed activating the dry contact switch.

Warning

It is imperative to refrain from supplying any voltage to these inputs, as they are not optically isolated. Consequently, connecting them to a voltage source may result in damage to the SCU5 controller.

Info

The availability of this digital input option is limited to legacy SCU5 hardware configurations. For new applications, it is recommended to utilize the DIO option.

4.4.9 Dry Contact Input + Opto-Isolated Output (Port 3)

The SCU5 controller, equipped with a digital input and output option (with suffix DIO), features a M12 12-pin male connector on this port. It offers 4x dry contact inputs and 4x NPN outputs. In the case of the DIO suffix, these input/output options facilitate remote control of the web guiding system from the machine PLC or other machine logic controllers. The wiring configurations for both the dry contact inputs and the NPN outputs remain consistent with those discussed earlier.

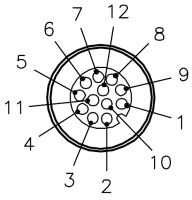
	Pin	Signal
	1	CGND
	2	IN 1
	3	IN 2
	4	IN 3
	5	IN 4
	6	NC
	7	VDD
	8	GND
	9	OUT 1
	10	OUT 2
	11	OUT 3 ¹
	12	OUT 4 ²

Table 4.7: Signal and Pin Number for M12 12-pin: 4x Digital Input (Dry Contact) + 4x Digital Output (NPN)

Digital I/O Cable Recommendations

Roll-2-Roll Technologies provides a standard M12 12-pin female to pigtail cable, 3 meters in length, for Digital I/O applications. The cable is named **M12 12-pin Digital I/O Cable (3m)** and its part number is **21228-3m**. Below is a list of recommended manufacturers along with their specific part numbers for the cable.

1. Turck: **RK 12T-3 (3m)**
2. Turck: **RK 12T-5 (5m)**
3. Turck: **RK 12T-10 (10m)**
4. Murr: **7000-19041-7050300 (3m)**
5. Murr: **7000-19041-7050500 (5m)**

M12 12-pin Male Connector Input Wiring

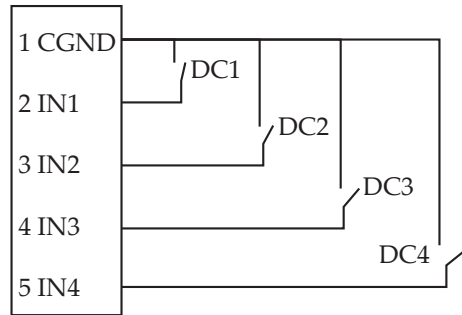


Figure 4.13: Typical wiring information for dry contact inputs

NPN Normally Closed Output

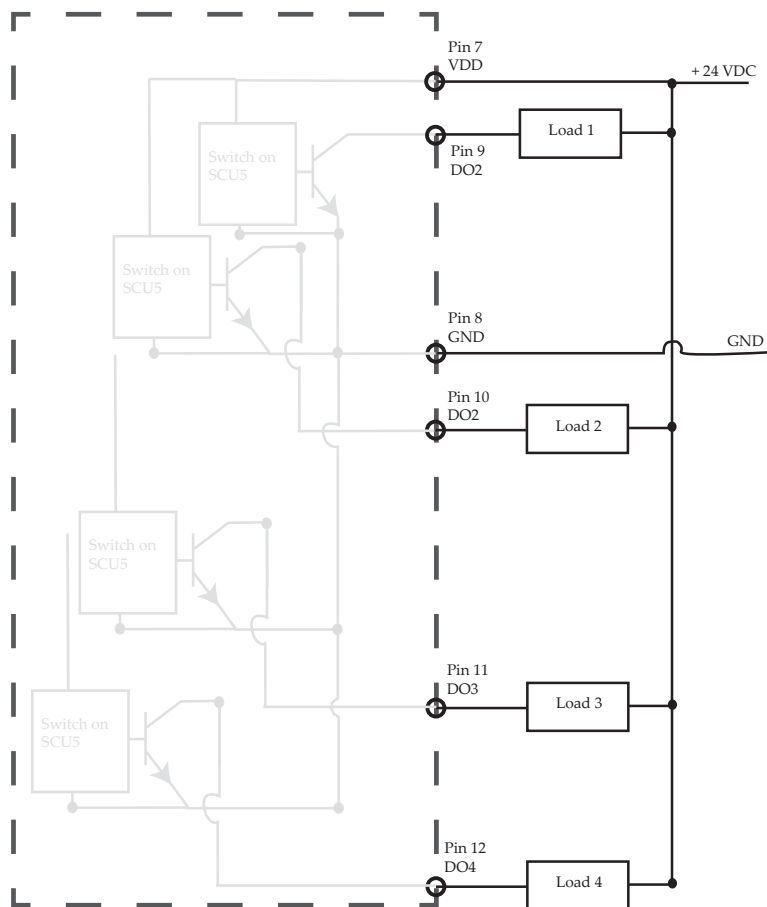


Figure 4.14: Typical wiring information for NPN normally closed output from SCU5 controller

6. Murr: 7000-19041-7051000 (10m)

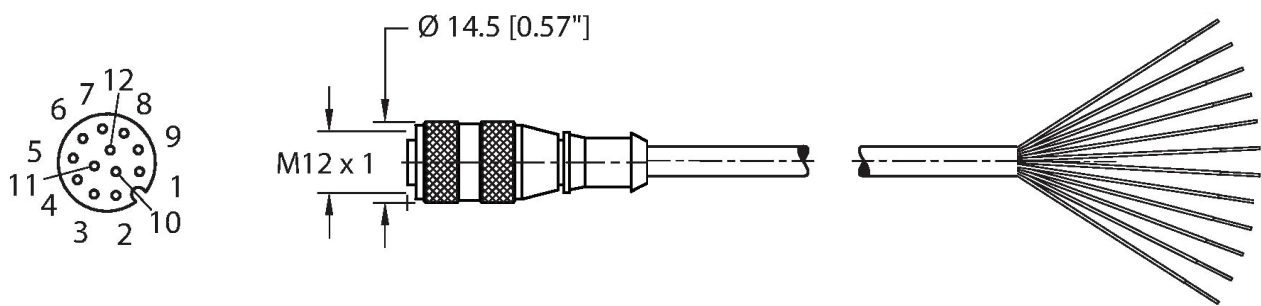


Figure 4.15: M12 12-pin Female to pigtail digital I/O cable

5. Operator Interface

The controller features a 3.2" wide color capacitive touchscreen with a glass bezel as its operator interface. Language-neutral icons and buttons are present on the touchscreen to facilitate a user-friendly human-machine interaction. This interface offers essential information and operator control for various functions such as web guiding, web width measurement, defect detection, flag detection, among others. Additionally, the touchscreen allows one to adjust the controller parameters specific to each application. As a result, the touchscreen operator interface is utilized for routine operations, as well as for maintenance and troubleshooting tasks.

Warning

Never use sharp or pointed tools of any kind to operate the interface.

Info

Touchscreen compatible gloves may be necessary when gloves are used.

5.1 Home/Main Screen

A screenshot of the home screen of the controller is as follows along with the description of the buttons.

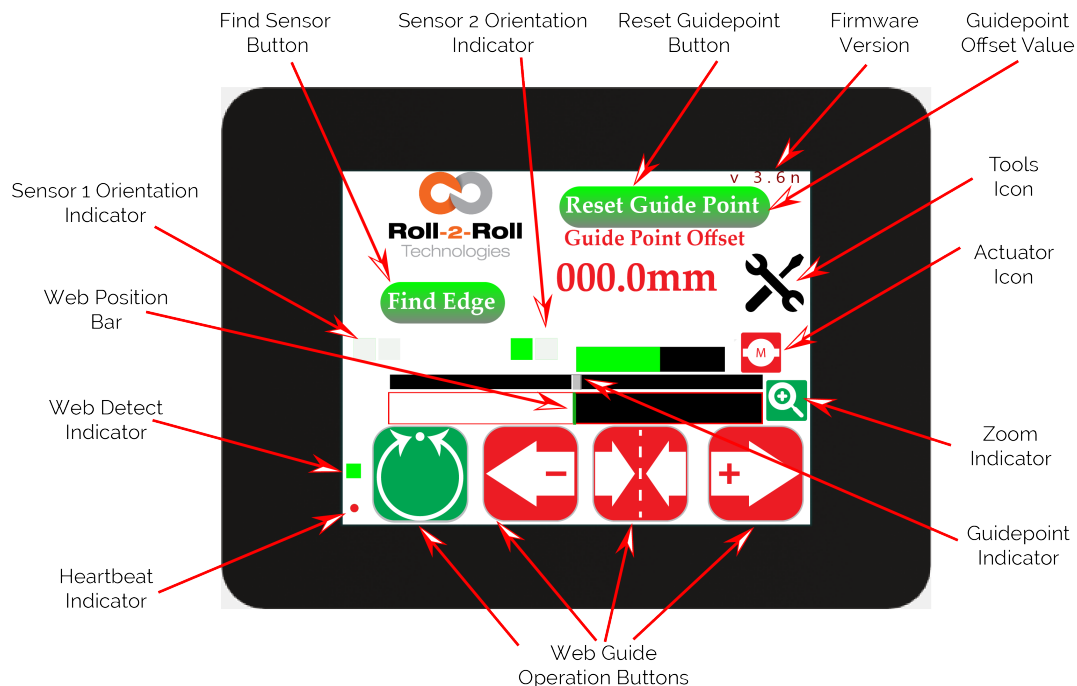


Figure 5.1: Controller Home Screen

5.1.1 Heartbeat Indicator

A circular marker located at the lower left corner of the operator interface serves as a signal for the heartbeat or the connection status between the motherboard on the controller and the touchscreen display. In typical circumstances, this marker alternates between red and green approximately once per second. In cases where the processing duration of the controller exceeds the standard, the blinking frequency of this marker decreases. Consequently, this marker is used for diagnostic tasks.

Note

A decreased heart rate could suggest an extended processing duration for the controller or a lag in communication between the primary motherboard and the touchscreen display/operator interface.

Warning

If the blinking of the heartbeat ceases or if the frequency of blinking is irregular, it suggests the presence of abnormal operational circumstances.

5.1.2 Web Detect Indicator

When the controller detects a valid edge, a square indicator located at the bottom left corner of the operator's home screen will change to green; if a valid edge is not detected, it will change to grey.

The determination of edge validity is contingent upon the sensing mode being used. In edge mode, an edge is considered valid if its quality factor exceeds a predefined threshold. Consequently, this indicator can serve as a web detect signal for edge detection in edge mode. In contrast mode, a valid edge is defined as one that exhibits the desired contrast or feature previously taught to the operator. Therefore, this signal can function as an indicator of loss of contrast in contrast mode.

The web detect indicator is valuable for troubleshooting purposes. If this indicator sporadically deactivates while a web is present in front of the sensor, it may suggest that the sensor is encountering challenges in accurately detecting the valid edge (web edge or contrasting feature), pointing to a situation of low contrast that signifies poor edge quality. Such circumstances may arise with optical-grade clear webs that exhibit low scattering in the infrared spectrum or when the sensor fails to detect the desired contrast feature. See the sensor [installation recommendation document](#) to help increase the scattering from the sensor and avoid issues with low contrast.

Note

- *When two sensors are connected in edge mode, the valid edge condition is based on either sensor detecting a valid edge.*
- *If there is no web in front of the sensor or if the sensor is completely covered by the web, the sensor will not detect a valid edge.*
- *When two sensors are connected in contrast mode, the correct edge condition aligns with the sensor selected for the contrast setting.*

Info

Roll-2-Roll® Sensors are utilized for detecting optically transparent film and clear glass with minimal haze, a task that can be achieved through appropriate sensor placement.

5.1.3 Web Position Bar

In the primary operator interface, a horizontal white bar against a black background is employed to show the web's position relative to the sensor(s) field of view. The white section represents the web by depicting the light that is reflected or scattered from it, whereas the black background signifies the lack of web presence, symbolizing darkness due to the absence of reflection or scattering from the web.

Note

- The width of the web position bar stays constant regardless of the measurement range of the sensor(s).
- When two sensors are connected, the web position bar divides into two sections to display the separate web positions detected by each sensor. A red line will be displayed in the center to show the separation between the two sensors.
- When in contrast mode, the web position bar will display only the image related to the chosen sensor. In this situation, the bar will display different shades of grey to represent the different levels of contrast found in the image for contrast mode.

One Sensor: One Edge

Depending on the number and orientation of the sensors, the web position bar will appropriately indicate the position of the web. For example, in Figure 5.2 *Sensor 1* orientation is configured to pick the left edge of the web. Hence, the left edge of the web position bar moves back and forth with the black (dark) region to the left of the edge.

A valid edge is indicated by a green line at the intersection of the black (dark) and white (web) region. Similarly, in Figure 5.3 the *Sensor 2* is configured to pick the right edge of the web. Hence, the right edge of the web position bar moves back and forth with the black region to the right of the edge position indicated by the green line.

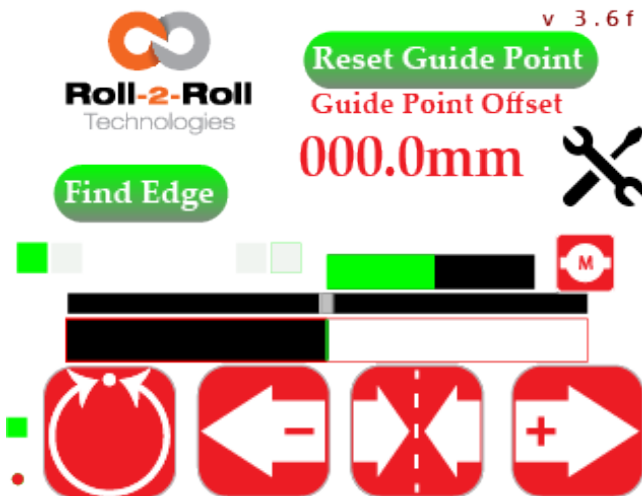


Figure 5.2: *Sensor 1* configured for left edge.

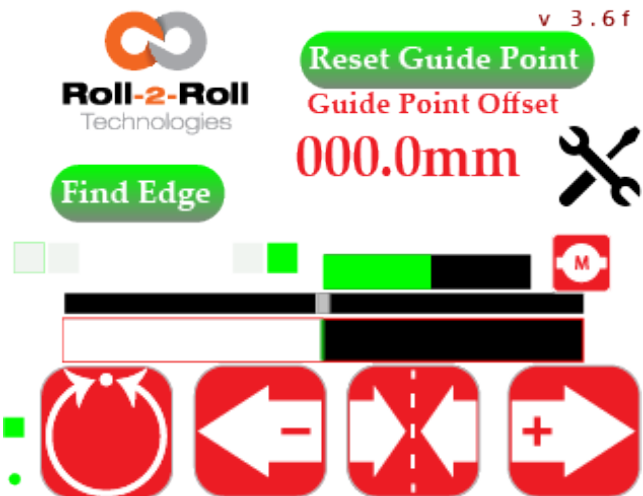


Figure 5.3: *Sensor 2* configured for right edge.

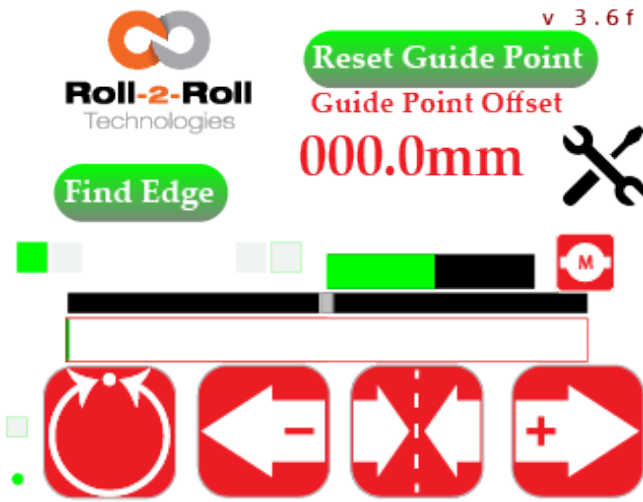


Figure 5.4: Fully covered state with left edge

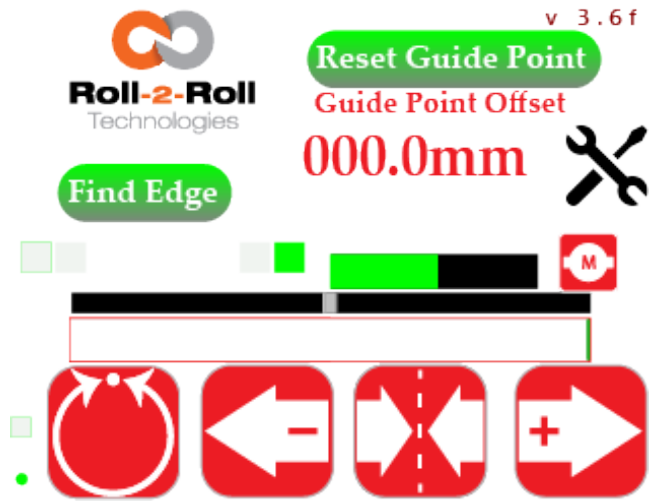


Figure 5.5: Fully covered state with right edge

Info

- If the sensor is fully covered by the web or if the web is incorrectly oriented, the web position bar will appear entirely white, as depicted in Figures 5.4 and 5.5. In such cases, the web detect indicator will turn gray, signaling the absence of a valid edge.
- In the absence of a web in the sensor viewing area, the web position bar will be entirely black. Additionally, the web detection indicator will turn gray, signaling the lack of a valid edge.

One Sensor: Both Edges

When a single sensor is utilized to monitor the centerline position of the web, the web's entirety, including its centerline position, is symbolized by the web position bar. For instance, in Figure 5.6, *Sensor 1* is set to center mode to capture the complete web; the web's position is depicted by the white rectangle within the black background. The green line running through the middle of the white rectangle represents the centerline position of the web. As the web move back and forth, both the white rectangle (indicating the web) and the green line (depicting the centerline position) shift within the black background. Figure 5.7 illustrates a similar scenario with *Sensor 2*.

The centerline position is computed by taking the average of the left-edge position and the right-edge position of the web.

Info

- In the absence of a web, the web position bar will be uniformly black. The green centerline position indicator will be positioned precisely in the middle of the bar, while the web detect indicator will change to gray.
- When the web fully obstructs the sensor's field of view, the web position bar will display as entirely white. The green centerline position indicator will still be centered within the bar, and the web detect indicator will shift to gray.

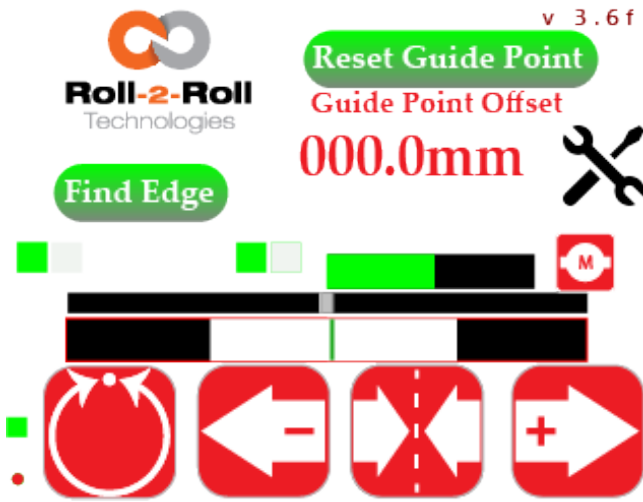


Figure 5.6: *Sensor 1* configured for centerline.

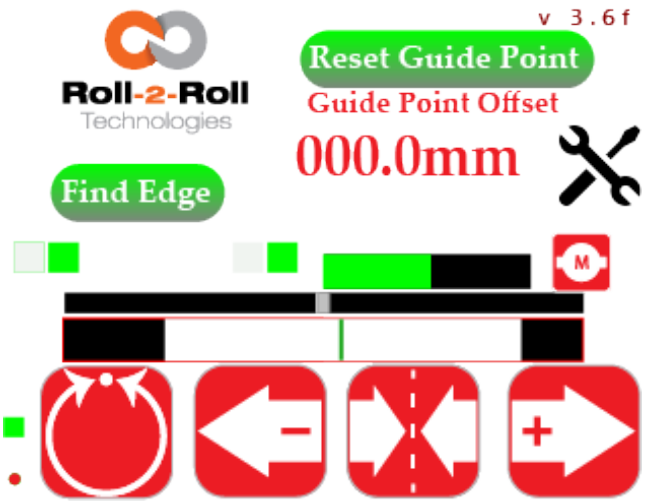


Figure 5.7: *Sensor 2* configured for centerline.

Two Sensor: Two Edges

When utilizing two sensors for monitoring the position of the web, the web position indicator will automatically adjust to display the position of the edge in relation to the two sensors.

The web views captured by the two sensors are automatically separated into a split-screen layout (with a red line in the center indicating the division between the two sensors) as illustrated in Figure 5.8. Each section corresponds to the range of the sensor (number of pixels in each sensor), and the position of the web in the field of view of each sensor is depicted by the white area.

The green line represents the position of the centerline. The centerline position C_l is determined by combining the proportional contributions of the web positions from the individual sensors, as illustrated below:

$$C_l = \frac{S1_e + S2_e}{S1_n + S2_n}$$

where $S1_e$ represents the edge position of *Sensor 1*, $S2_e$ represents the edge position of *Sensor 2*, $S1_n$ represents the number of pixels in *Sensor 1*, and $S2_n$ represents the number of pixels in *Sensor 2*. Therefore, on the display, the green line illustrates the relative position of the centerline within the span of the two sensors.

Info

- If neither sensor detects the web, the web position bar would display as entirely black with a green line in the center, as illustrated in Figure 5.10.
- If the web covers both sensors entirely or if it enters from the incorrect direction with both sensors, the web position bar would show as entirely white with a green line in the middle, as depicted in Figure 5.11.
- In both scenarios mentioned above, the web's centerline position is precisely in the middle.

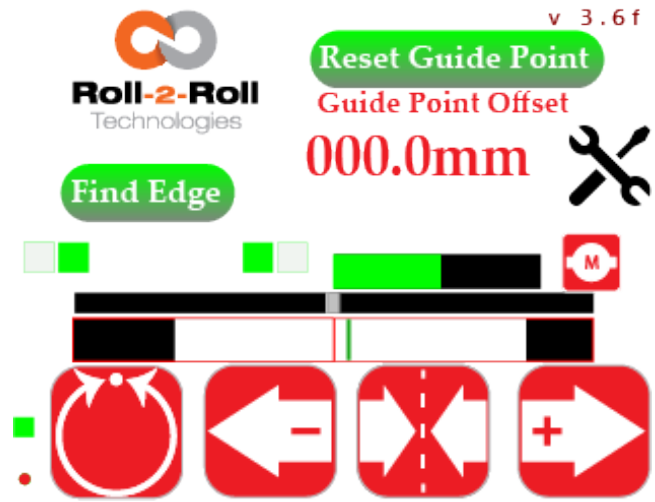
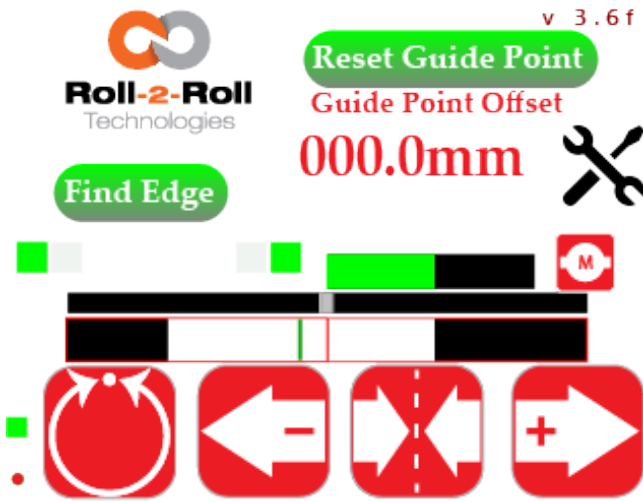


Figure 5.8: Sensor 1 left edge, Sensor 2 right edge. Figure 5.9: Sensor 2 left edge, Sensor 1 right edge.

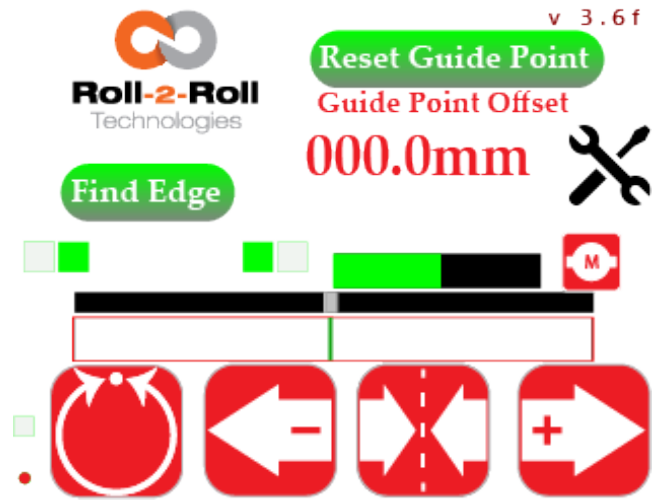
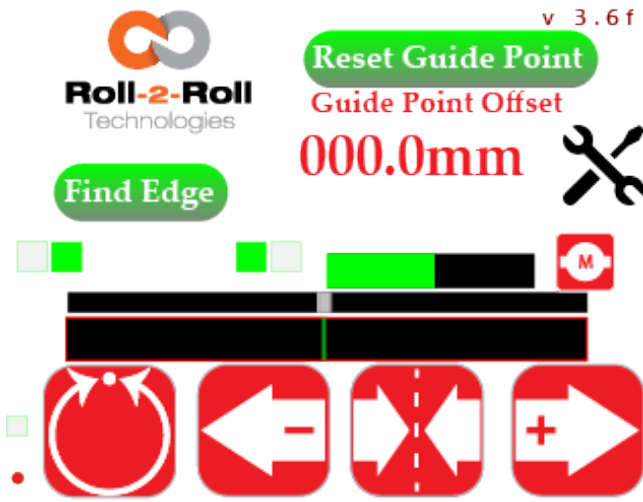


Figure 5.10: Fully open with two sensors.

Figure 5.11: Fully covered with two sensor.

 **Note**

- Using two sensors with an equal number of pixels is advised when employing the center mode to prevent ambiguity.
- When one sensor is configured to detect the left edge and the other to detect the right edge (as illustrated in Figure 5.6 and 5.7), the left edge of the web is consistently displayed on the left side of the web position bar, while the right edge of the web is consistently displayed on the right side of the web position bar. Thus, in Figure 5.6, the left portion of the web position bar represents the web position detected by Sensor 1, whereas in Figure 5.7, the left portion of the web position bar indicates the web position detected by Sensor 2.
- When both sensors are configured with the same sensor orientation, the left split screen consistently displays Sensor 1, while the right split screen displays Sensor 2. The calculation of

the centerline position remains unchanged, following the same method as previously demonstrated.

Warning

- Avoid setting both sensors to the same orientation without consulting Roll-2-Roll Technologies about the application. While the controller will function as intended, it may not be user-friendly and could lead to confusion.
- Refrain from configuring both sensors to center mode without consulting Roll-2-Roll Technologies regarding the application. Although the controller will perform its functions correctly, it may not be straightforward for the operator and could result in misunderstandings.

Contrast Mode

When in contrast mode the web position bar changes in such a way that it shows a live preview of the different contrasting features on the web as shown in Figs 5.12 and 5.13

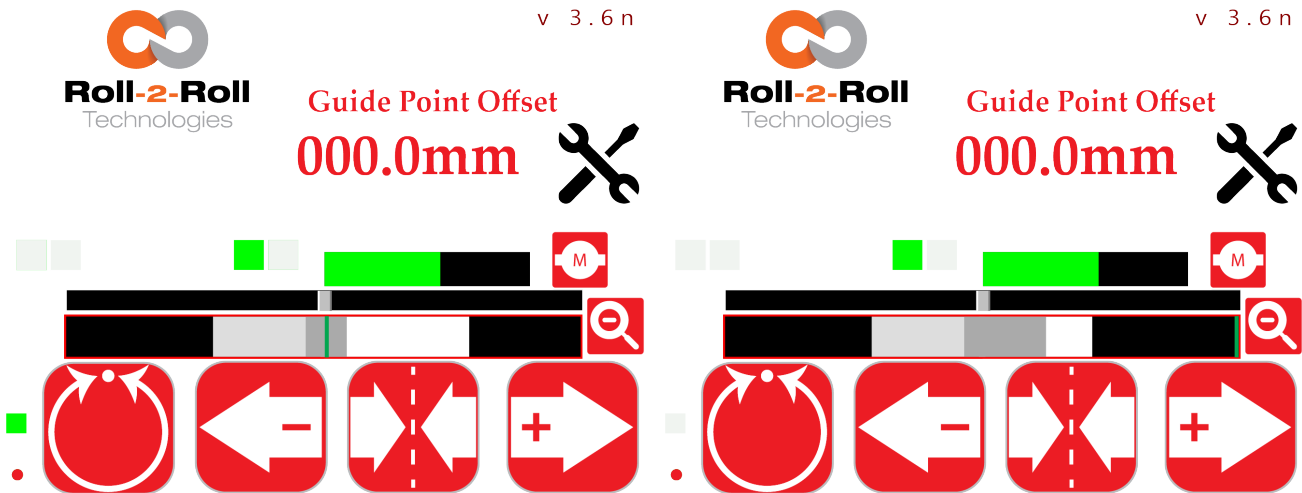


Figure 5.12: In the contrast mode, the real-time sensor image is shown on the web position bar. Figure 5.13: In the contrast mode, the real-time sensor image is shown on the web position bar.

Note

- When two sensors are connected, the live preview will show solely the image associated with the selected sensor to aid in contrasting guidance.
- As the contrasting feature is tracked, the web detection indicator functions as a signal to detect valid contrast. Consequently, when the tracked contrast feature is visible in the sensor's field of view, the web detection indicator will change to green (Fig 5.12), and it will switch to grey when the contrast is no longer detected (Fig 5.13).

Info

When operating in automatic mode, if the sensor does not detect the contrast being monitored, the actuator will be automatically deactivated.

5.1.4 Sensor Orientation Indicator

The four sensor orientation indicators offer a rapid indication of how each sensor is positioned. Each sensor has the option to be positioned to detect the left edge, right edge, or both edges. The pair of indicators on the left side corresponds to the left orientation for *Sensor 1* and *Sensor 2*, while the pair on the right side corresponds to the right orientation for both sensors.

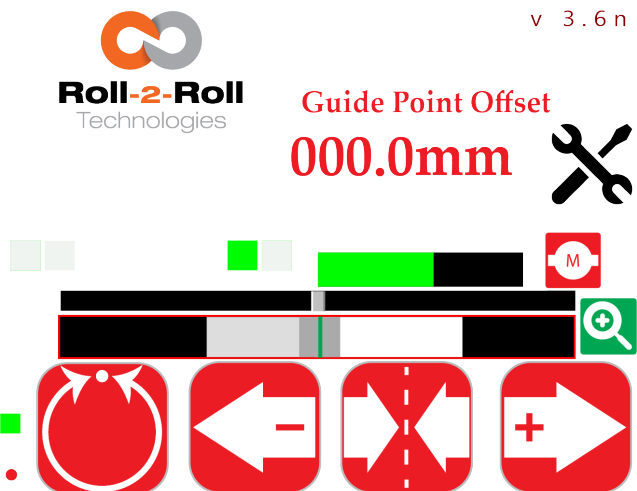
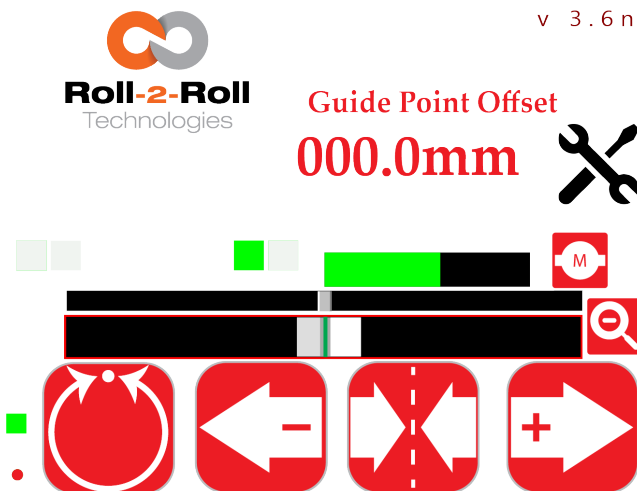
If a specific orientation is selected for a sensor, the respective indicator will turn green; otherwise, it will remain gray, as depicted in Figures 5.2, 5.3, 5.6, 5.7, 5.8, and 5.9.

Info

When a sensor is not connected to a sensor port or is electronically deactivated, the orientation indicators associated with it will be displayed in gray. This feature offers prompt feedback to the operator, particularly when changing sensors for various tasks.

5.1.5 Zoom Indicator

In specific cases where a broad sensor is utilized for contrast-guiding purposes, it might be essential to focus solely on a smaller area within the sensor for viewing or processing. This can be accomplished by choosing a region of interest and magnifying that area on the screen. When this functionality is activated, the zoom indicator icon changes to green, signaling that processing is limited to a smaller region of interest. Otherwise, the icon remains red.



Info

This serves as a visual cue on the main screen. The activation or deactivation of this function can only be carried out from the operator sensor screen. For more information about this feature, please refer to Section 5.5.14.

Note

- The zoom indicator is only valid when the sensor is in contrast guiding mode.
- This functionality is only available in firmware version v3.6n and above.

5.1.6 Actuator Position Bar

The actuator position bar displays the current electronic position of the actuator in real-time. The green bar visually represents the extension and retraction of the actuator. When the actuator position nears its maximum electronic stroke limits, the color of the bar changes to yellow (alert) or red (warning), signaling the proximity to the limits (refer to Figure 5.16 – 5.19). Upon reaching these electronic limits, the actuator ceases movement in that direction, causing the bar to turn entirely red (fully extended) or completely black (fully retracted).

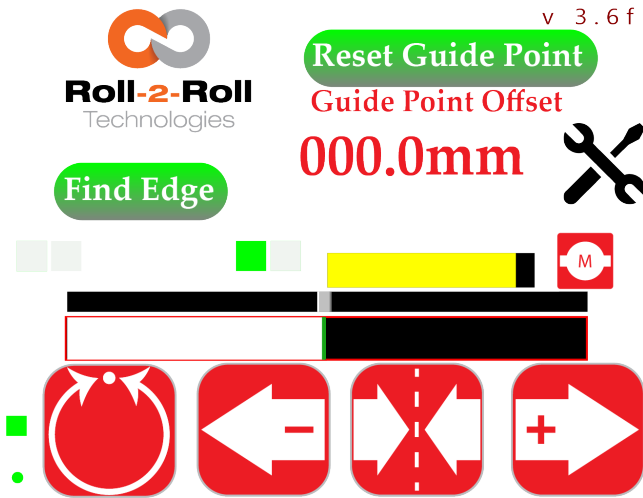


Figure 5.16: Actuator Extended Position Alert

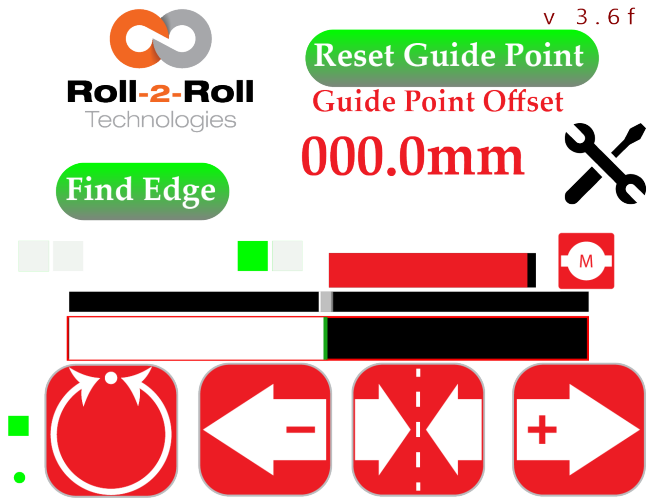


Figure 5.17: Actuator Extended Position Warning

Info

The center of the actuator position bar represents the home position or servo center position of the web guiding system.

Note

The actuator position refers to the electronic step count position monitored by the Roll-2-Roll® Driver. In the case of a stepper motor driver, this represents an open-loop position control.

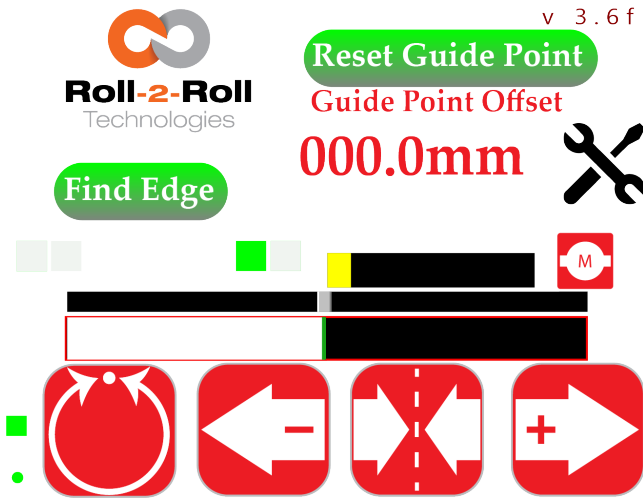


Figure 5.18: Actuator Retracted Position Alert

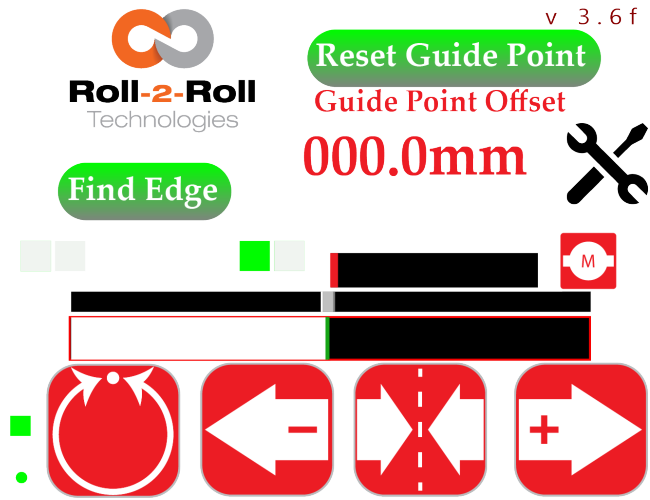


Figure 5.19: Actuator Retracted Position Warning

Warning

- The actuator position bar might remain stationary if a suitable Roll-2-Roll[®] Driver is not connected to the controller or if there is a communication error between the controller and an appropriate Roll-2-Roll[®] Driver.
- The actuator position bar should display seamless real-time movement when the web guide is in operation. If the movement of the bar is uneven or sporadic, it suggests communication issues between the controller and the Roll-2-Roll[®] Driver. This is an abnormal occurrence and requires immediate attention.
- If the actuator connected to the Roll-2-Roll[®] Driver moves but the actuator position bar does not show any movement (appearing either completely black or red), this could be attributed to a corrupted electronic position of the actuator in the memory. This is not a standard situation and needs to be addressed promptly.

The actuator extension direction can vary based on the motor's polarity, moving either from left to right with standard polarity (see Figure 5.20) or from right to left with reverse polarity (see Figure 5.21).

5.1.7 Find Edge Button

The operator uses the find edge button to select the job according to the desired edge for sensing and guiding purposes. This button has a dual function depending on the sensor configuration on the power user screen (see Section 5.14).

1. **Automatic detection of sensor orientation:** When one or both sensors are configured to automatically detect orientation (see Section 5.14), pressing the find edge button will determine the correct orientation of the sensor(s) relative to the web within the sensor's field of view.
2. **Activation and deactivation of sensors:** If both sensors are set to a predefined orientation (see Section 5.14), pressing the find sensor button will alternately activate and deactivate the connected sensors electronically.

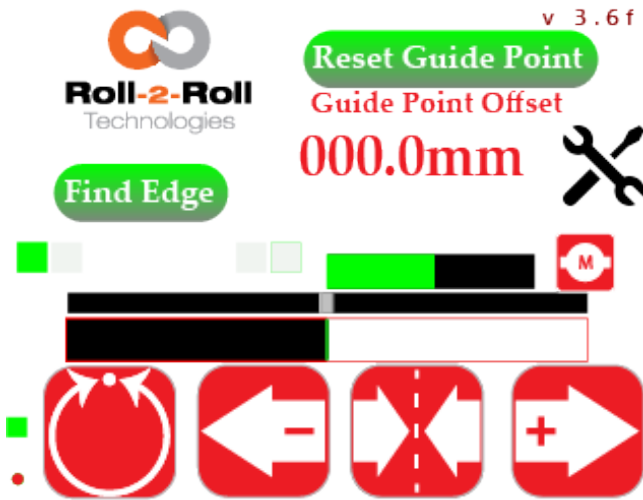


Figure 5.20: Actuator Standard Polarity

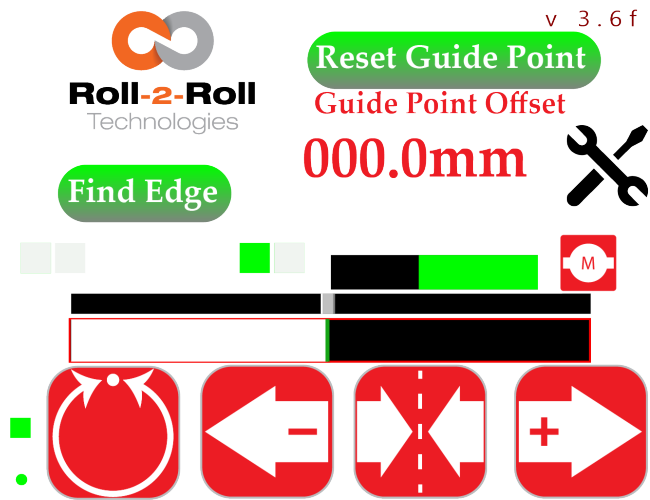


Figure 5.21: Actuator Reverse Polarity

 **Note**

The find edge button will not be visible in contrast mode (see Fig 5.12 and Fig .5.13) or when the web guide is in automatic mode.

Automatically find the sensor orientation

In this mode, pressing the find edge button automatically detects the sensor orientation relative to the web. This feature facilitates swift job changes when the sensor is relocated within the machine, particularly beneficial when using a single sensor for selecting the left edge, right edge, or both edges. This functionality is activated whenever there is a change in the sensor orientation concerning the web. For instance, shifting the sensor from the operator side to the drive side during a job prompts pressing the find edge button to toggle the sensor mode from left edge to right edge (or vice versa) as soon as the repositioning occurs. If both edges of the web are visible within the sensor's field of view, the sensor orientation switches to center mode.

 **Note**

- As long as the sensor orientation relative to the web remains constant, there is no necessity to press the find sensor button for each job.
- The automatic find sensor orientation functionality should be enabled in the Power User sensor screen. For more information, refer to Section 5.14.

 **Warning**

It is important to note that automatic detection of the sensor orientation only operates when the web is within the sensor's field of view. In the absence of the web in the field of view, the sensor orientation indicators will appear gray until a valid edge is detected within the sensor's field of view.

Enable and disable the sensors

When the sensor orientations are fixed, the find edge button enables users to easily activate or deactivate the sensors for quick adjustment of tasks. For instance, if two sensors are linked to the controller with specific orientations, pressing the find edge button repeatedly would result in the following:

1. Enable sensor 1 and disable sensor 2
2. Enable sensor 2 and disable sensor 1
3. Enable both sensor 1 and sensor 2
4. Disable both sensor 1 and sensor 2

Info

If only one sensor is connected, pressing the find edge button successfully will result in the following effect:

1. Enable the connected sensor
2. Disable the connected sensor

Note

- *If any sensor is configured for automatic orientation, pressing the find edge button will not activate or deactivate the sensors. Instead, the controller will return to the automatic sensor orientation detection feature.*

5.1.8 Auto/Manual Button

The controller used for web guiding applications can switch between manual and automatic operation modes by simply pressing the designated icon. Pressing this icon will alternate the controller between manual and automatic modes. In a web guiding system, the automatic mode adjusts the position of the web guide structure to align the web with the desired location.



Manual Mode Icon



Automatic Mode Icon

Info

Pressing the automatic mode button causes certain icons on the screen to disappear depending on their functionality.

Note

- *From firmware version 3.6n onwards, this feature can be utilized with the analog output for web alignment tasks when the analog output is linked to an external web guide controller.*
- *This feature is irrelevant for sensing applications. Nevertheless, certain specialized applications with customized firmware might make use of this feature, so please consult any relevant*

supplementary documentation.

- In case no sensor is connected or enabled, the controller cannot be switched to automatic mode.

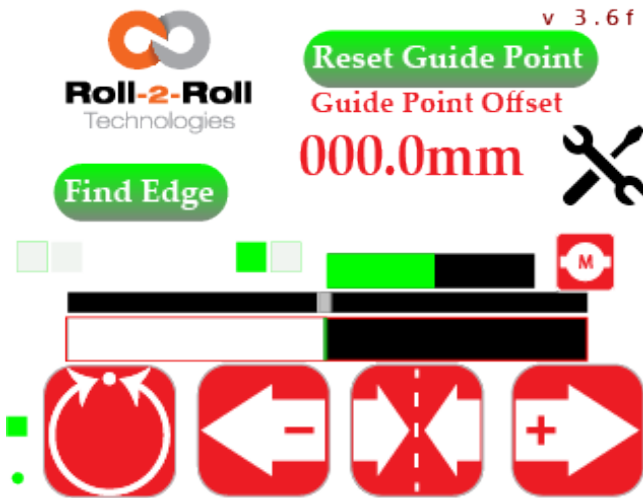


Figure 5.22: Controller in manual mode

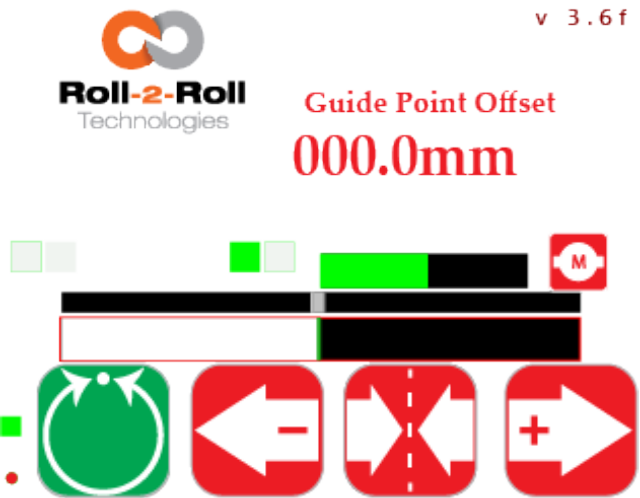


Figure 5.23: Controller in automatic mode

Warning

- Transitioning from one mode to another may lead to a shift in the web guide's position, potentially causing process disturbances. It is essential to proceed with caution when switching operating modes, ensuring that only individuals fully aware of the implications carry out the change.
- Under no circumstances should any personnel manually interact with the web guide or the materials in its vicinity while the guide is in automatic operation. Disregarding this caution could lead to bodily injuries due to crushing at pinch points in and around the web guiding system.
- It is crucial to ensure that only one person is involved in adjusting the guide during manual operation. Neglecting this precaution could result in bodily harm at pinch points within and around the web guiding system.

5.1.9 Servo Center

The servo center¹ serves as the default position for the actuator, facilitating efficient product changeovers. For intermediate web guides, this position aligns the rollers on the guide frame parallel to those on the machine frame. When dealing with an unwind or rewind, the servo center corresponds to the actuator stroke being midway between its mechanical extremes. This feature enables quick centering of the guide for smooth web threading during changeovers.

¹The term "servo center" is a historical term that refers to the default position of the servo or servo control valve.

To reposition the web guide to the servo center, the controller can utilize a physical sensor (such as electronic or mechanical switches) or software (like digital motor position count). Electronic switches such as inductive proximity sensors, reed switches, or capacitive proximity sensors can function as servo center sensors, requiring connection through a suitable Roll-2-Roll[®] Driver to activate the servo center functionality. For details on wiring the appropriate electronic or mechanical switch, please consult the relevant driver documentation.

When the controller is set to manual mode, pressing the servo center icon will trigger the servo centering process. Activating this momentary switch will change the icon color to green, indicating that the servo centering is in progress. During the servo centering mode, the actuator linked to the controller will move towards either the home or center position (refer to Figure 5.24). Once the actuator reaches the home or center position, it will halt, and the status of the temporary switch will transition from Servo-centering (Green) to the Default/normal state (Red) (refer to Figure 5.25).



Default/Normal Mode



Servo Centering Mode

The servo center position holds significance for Roll-2-Roll[®] Controllers. The software keeps a record of the actuator's position, and the electronic actuator stroke limits are determined based on this position. The actuator is instructed to move within half of the stroke length on either side of the servo center position. Therefore, whether the actuator is jogged manually or during automatic control, the Roll-2-Roll[®] Driver ensures that the actuator does not exceed the electronic stroke limits monitored by the controller. This approach offers a cost-effective means of safeguarding the actuator by preventing it from colliding with the mechanical limits of the web guiding system. Additionally, the controller can utilize end limit switches (mechanical or electronic) at the end of the stroke if needed; for further details, please see 5.15.6.

Info

During the process of servo centering, the actuator position bar will continuously display the real-time actuator position. Once the operation is finished, the actuator position bar will accurately show the midpoint within the actuator position window, indicating the central position. It is common for the actuator position indicator to suddenly shift to the center of the window at the conclusion of the servo centering process. This occurrence is typical when there is a variance between the previous and current servo center positions, either mechanically or electronically, in relation to the actuator.

Note

The process of servo centering can only be carried out when the web guiding system is set to manual mode. If the servo center icon is pressed while the system is in automatic mode, it will execute a different operation.

Warning

- The process of servo centering leads to a shift in the position of the web guide, which can disrupt the process. It is essential to approach this task with care and ensure that only individuals fully*

aware of the implications of this adjustment carry it out.

- The servo-centering process is automated within the web guiding system. It is crucial that no manual interventions are made by staff in the vicinity of the guide during this operation. Neglecting this caution may lead to the risk of body parts being caught and crushed at the pinch points both around and inside the web guiding system.

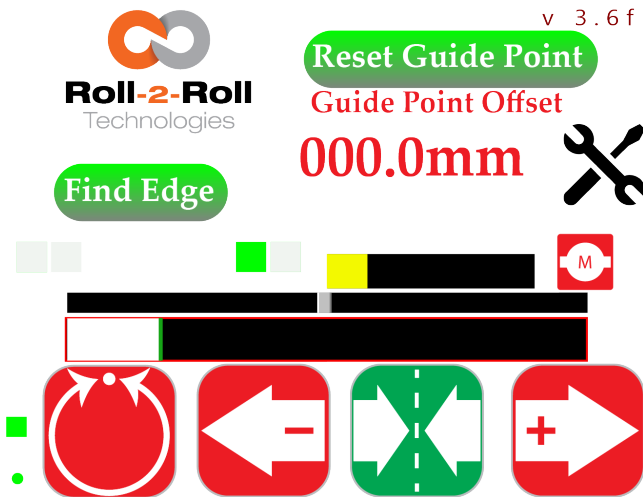


Figure 5.24: Servo Centering

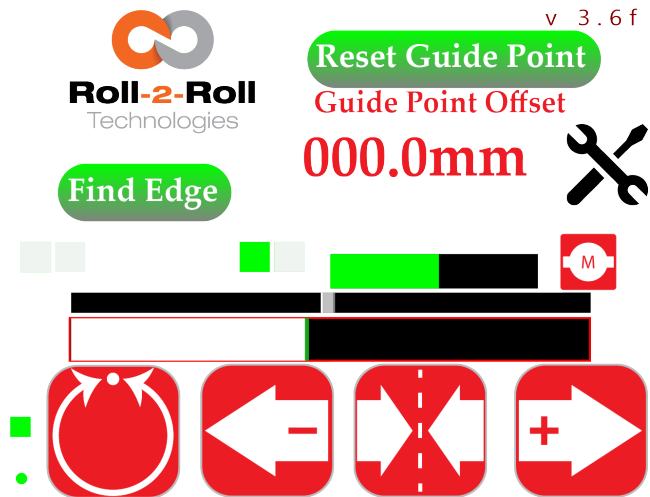


Figure 5.25: Servo Centering Completed

5.1.10 Jog Left/Jog Right Icon

The icons for Jog-Left and Jog-Right enable the operator to manually control the movement of an actuator linked to the controller using an Roll-2-Roll® Driver. These actions are restricted to manual mode on the controller. Both icons function as a momentary switch, illuminating in green when activated and in red when deactivated. The actuator will move according to the motor's polarity in the specified direction.

The Jog function will remain active while the button is being pressed and will cease as soon as the button is released. This function is only available when the guide is set to manual mode.



Info

The manual jog function enables the actuator to be displaced within the electronic stroke boundaries. During this process, the current position of the actuator is continuously shown in the Actuator Position Indicator window, depicted in Figure 5.26 and 5.27. If the button is pressed towards a direction where the electronic limit is met, the actuator will not move further in that specific direction.

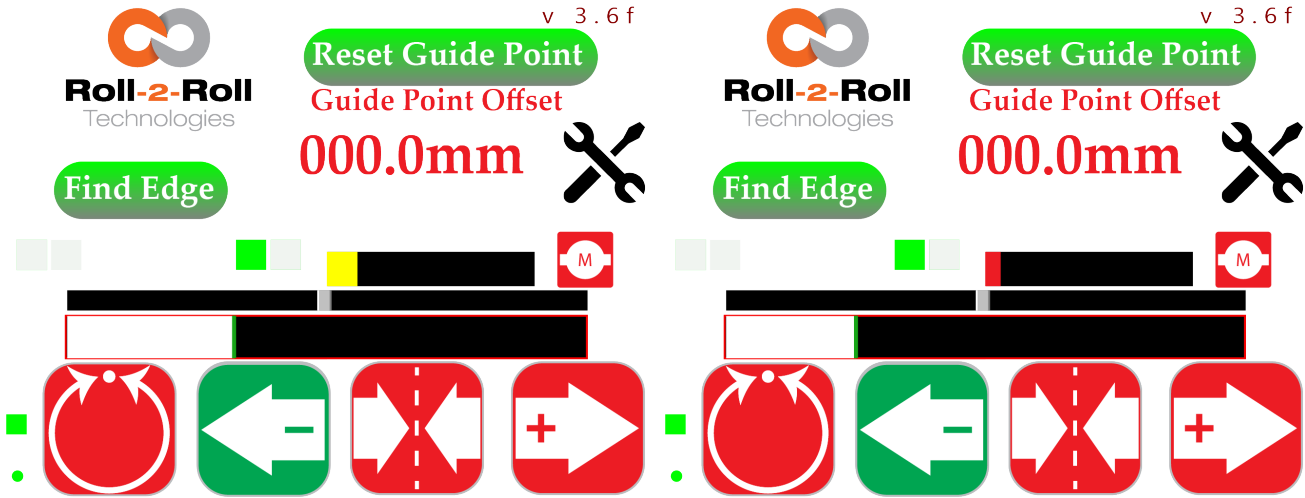


Figure 5.26: Jog Left: Actuator Position Alert

Figure 5.27: Jog Left: Actuator Position Warning

Note

- The Jog-Left and Jog-Right functions are only accessible in manual mode of the web guiding system. If these icons are pressed while in automatic mode, they will execute a different action.
- This feature is not relevant for sensing applications, but it may be utilized in specialized applications with unique firmware.

Warning

- The Jog-Left and Jog-Right actions lead to a shift in the position of the web guide, which can disrupt the process. It is crucial to handle these operations with care and only by individuals who grasp the implications of this adjustment.
- This is a manual process for the web guiding system. It is imperative that no staff engage in tasks near the guide when carrying out the jogging process. Disregarding this caution may lead to body parts being caught and crushed at the pinch points in and around the web guiding system.

5.1.11 Guide point Indicator

The guide point serves as the target position within the sensor's field of view where the web should be placed for web guiding purposes. It is the designated reference point for calculating the web's position error in web guiding applications. In automatic mode, the web guide controller uses the difference

between the guide point and the actual web position to guide the actuator towards the correct direction in order to reduce the error.

Usually, the guide point is positioned at the precise center of the sensor window or range. Nevertheless, the guide point can be electronically adjusted to any position within the detection area to facilitate rapid product changeovers.

The guide point indicator, located above the web position indicator, visually shows the current guide point in relation to the sensor window or range. When operating in automatic mode, the web position (either the edge position or the centerline position) will align with the guide point indicator if the web guide is functioning correctly.

Info

The electronic guide point adjustment minimizes the necessity of manually adjusting the sensor when switching tasks. When the sensor's field of view is sufficiently broad, this feature allows for rapid changeovers, decreases the occurrence of operator mistakes, and enhances operator safety by eliminating the requirement for manual sensor readjustment.

Note

When two sensors are employed, the guide point lies within the collective field of vision of both sensors.

5.1.12 Guide Point Offset Value

In addition to indicating the visual guide point position, the numerical guide point offset from the sensor(s) field of view is presented as a signed numerical measurement in millimeters (or inches). A guide point with an offset of 0 is precisely at the center of the sensor(s) field of view. A positive offset places the guide point on the right half of the sensor(s) field of view, whereas a negative offset situates the guide point on the left half of the sensor(s) field of view.

5.1.13 Gross Guide Point Adjustment

The primary purpose of the gross guide point adjustment is to facilitate a significant adjustment in the guide point, typically following a product switch where the web width is altered. This feature enables the operator to modify the reference position without the need for manual sensor adjustment, thereby expediting product changeovers and improving safety measures simultaneously.

This modification can be performed by moving the visual guide point indicator track bar to the preferred position, as illustrated in Figure 5.28. Releasing the track bar will trigger a confirmation accept button that needs to be pressed in order to finalize the gross guide point adjustment, as depicted in Figure 5.29.

The modification of the guide point must be verified by clicking the “Accept” button that is displayed when the track bar is adjusted (refer to Figure 5.29). This verification is implemented to avoid unintended alterations to the guide point. If the guide point modification is not confirmed within a timeframe of 5 to 10 seconds, the adjustment will be ignored, and the previous guide point offset will be reinstated.

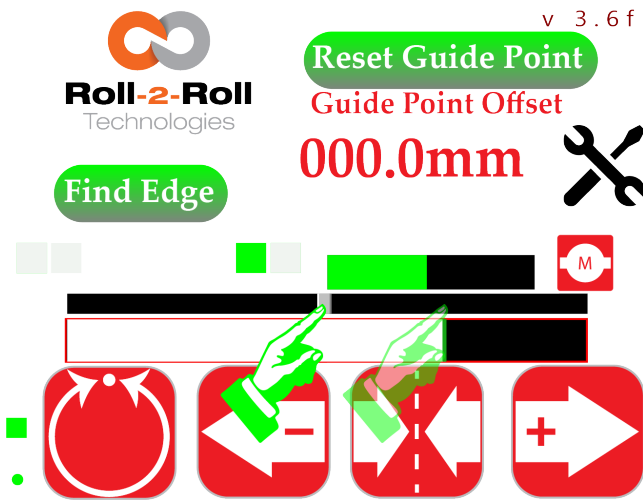


Figure 5.28: Gross guide point change by moving the track bar

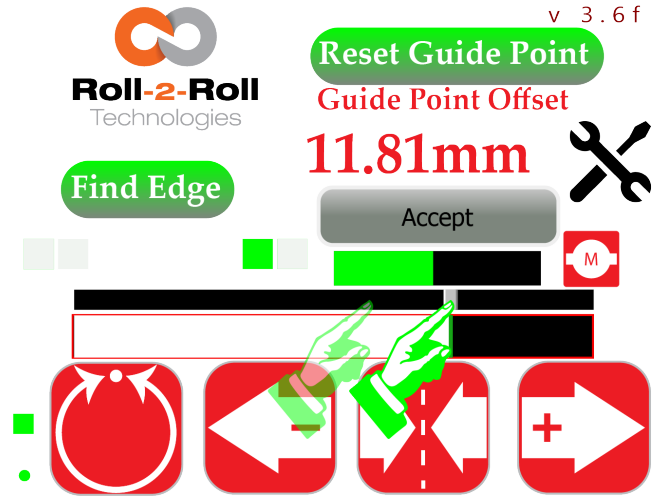


Figure 5.29: Release of track bar will prompt confirmation of the new guide point offset

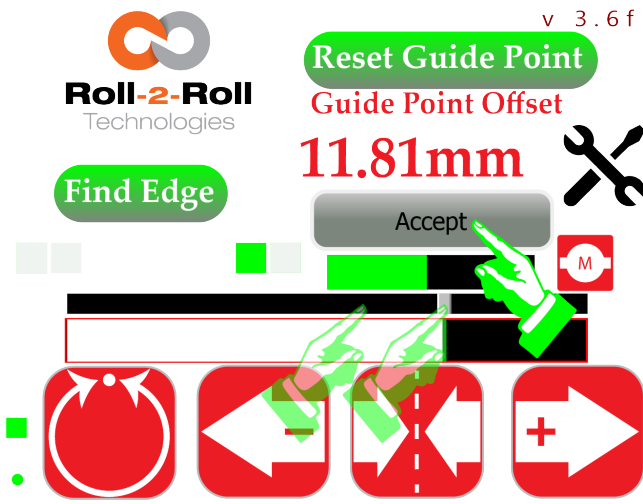


Figure 5.30: Gross guide point change needs to be accepted

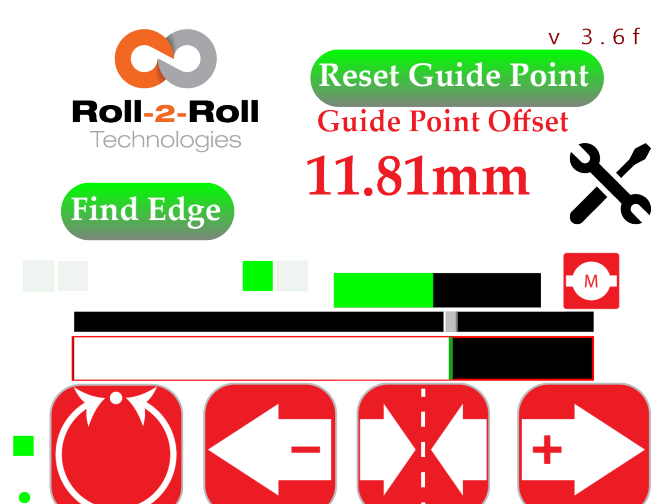


Figure 5.31: New accepted guide point is confirmed

Info

If the accept button is not clicked within a 5 to 10-second timeframe, the modification to the gross guide point will not be verified. This measure is implemented to avoid inadvertent touch inputs on the guide point track bar.

Note

The track bar is only movable when the web guide is set to manual mode.

Warning

The slider cannot be freely positioned, particularly near the limits of the sensor range. To ensure precise control, any adjustment point near the sensor range limits will be disregarded; instead, it will be adjusted to a minimum distance of 50 pixels from the sensor range boundary.

5.1.14 Reset Guide Point

The adjustment of the gross guide point can be automated by relocating it to the current web position. This feature facilitates swift guide point modifications, particularly when transitioning between products that result in significant changes in web width. Resetting the guide point is only possible when the controller is set to manual mode.

To reset the guide point to the current web position, the operator must press the reset guide point button (refer to Figure 5.32). Upon pressing the button, the controller will temporarily adjust the guide point to the current web position, as indicated by the guide point offset value displayed in Figure 5.33. Nonetheless, the new guide point location will not be finalized until the operator presses the "Accept" button (see Figure 5.34). Once the accept button is activated, the new guide point is confirmed, and the guide point track bar shifts to that position, signifying the guide point adjustment, as illustrated in Figure 5.35.

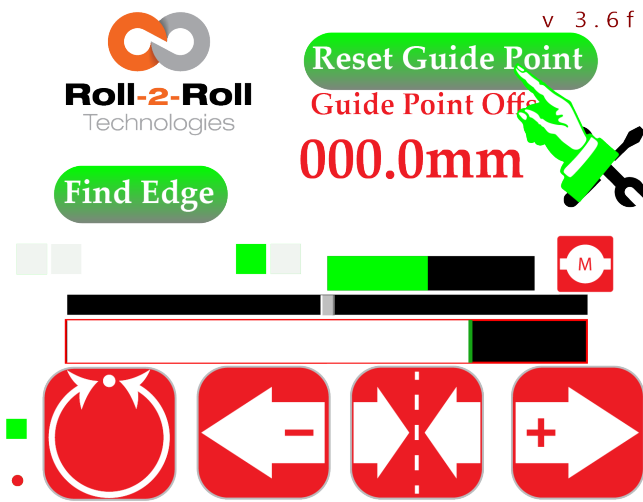


Figure 5.32: Guide point reset initiated by pressing reset guide point button

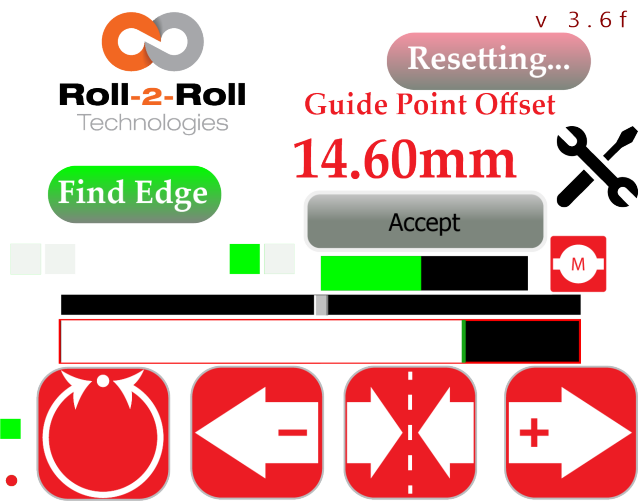


Figure 5.33: Temporary guide point change based on the current web position is displayed

Info

The resetting of the guide point depends on the present position of the web. This position can be determined by a single sensor at the edge or centerline of the web, or by a combination of a sensor at the centerline with another sensor, or by the contrast position detected by the selected sensor.

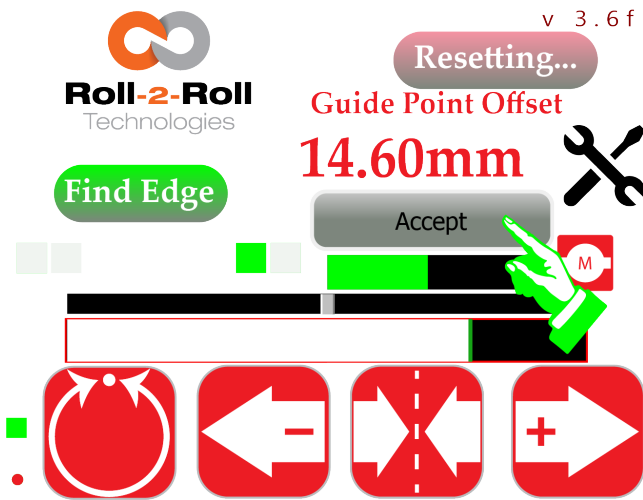


Figure 5.34: Temporary guide point not confirmed until the accept button is pressed

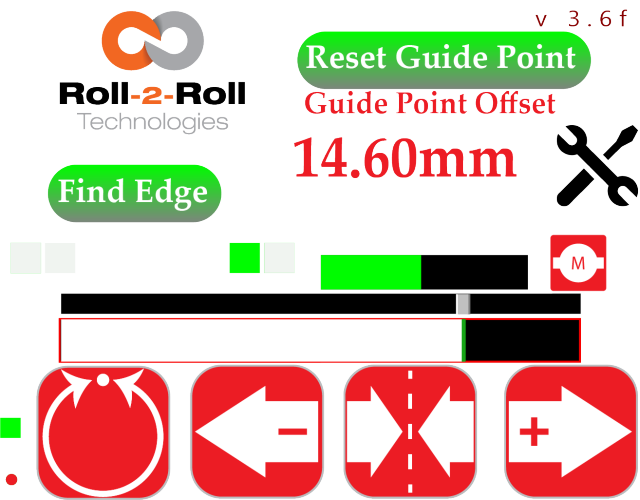


Figure 5.35: Gross guide change is confirmed and accepted

Note

The guide point is prohibited from being positioned too close to the left or right edge of the sensor's range. It will be automatically adjusted to a minimum distance of 50 pixels from the sensor's range.

Warning

If there is no web within the sensors' field of view, or if the web fully obstructs the sensors' field of view, the reset guide operation will yield unfavorable outcomes. The guide point might be positioned at the farthest edge of the sensor's field of view. Therefore, this procedure should be avoided when a valid edge is not visible on the web position bar.

5.1.15 Fine Guide Point Adjustment

Fine guide point adjustments to the guide point is performed when the controller is set to automatic mode. These modifications enable the operator to fine-tune the ultimate position of the guided web without the necessity of manually relocating the sensors, thereby improving the safety of the operation.

Fine Guide Point Adjustment: Increment/Decrement

When the web guide operates in automatic mode, if the Jog Right (+) button is pressed, the guide point offset will increase by 0.254 mm or 0.01" (refer to Figure 5.36). Conversely, pressing the Jog Left (-) button will decrease the guide point offset by the same amount (0.254 mm or 0.01", as shown in Figure 5.37). This adjustment is promptly reflected in both the visual guide point indicator and the numerical guide point indicator.

Guide Point Offset
0.254mm

Guide Point Offset
-0.762mm

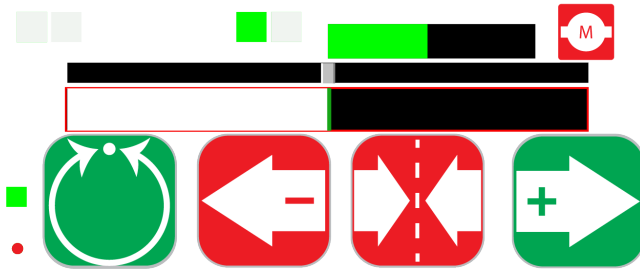


Figure 5.36: Fine guide point increment



Figure 5.37: Fine guide point decrement

 **Note**

- This button is momentary, and each press will adjust the guide point offset by 0.254 mm or 0.01". To change the guide point offset by a greater amount, multiple presses are required.

 **Warning**

- Inadvertent pressing of the Jog Left and Jog Right buttons will immediately alter the guide point offset.
- Making adjustments to the guide point can lead to shifts in the web guide position, potentially causing disruptions in the process. It is crucial to handle this task with care and entrust it to individuals who grasp the implications of such modifications.
- Adjusting the guide point should only be done when essential and by staff members who possess a thorough understanding of the repercussions of the adjustment. If the guide point deviates significantly from the desired 50% setting, the performance of the guiding system may suffer. Certain alterations may not have any impact if the web guide is positioned extremely.

Guide Point Adjustment: Reset to Zero

Whenever the controller is operating in auto mode, the guide point offset can be returned to zero by pressing the central button (refer to Figure 5.39). To prevent inadvertent actions, the reset to zero must be validated by pressing the accept button, as depicted in Figure 5.40.

 **Note**

This functionality has no meaning for sensing application. However, some custom applications with custom firmware may use the functionality.

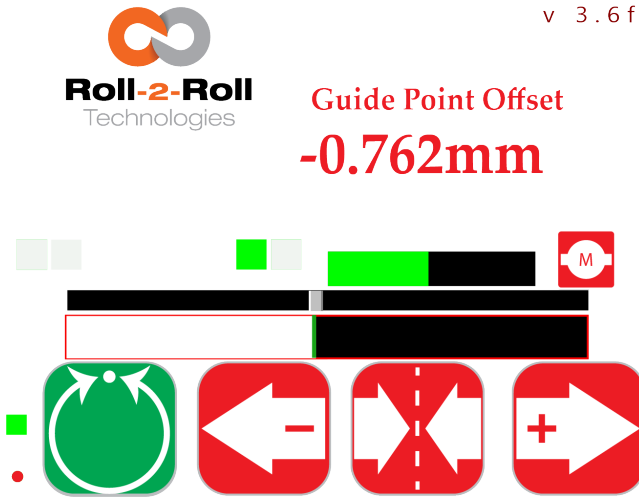


Figure 5.38: Fine guide point increment

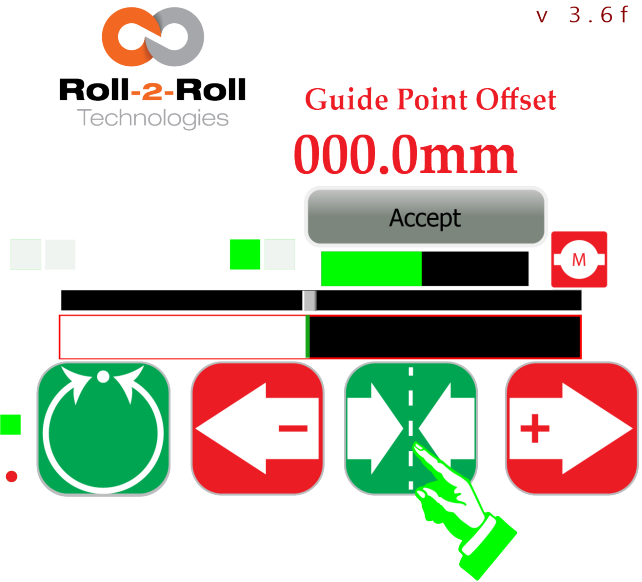


Figure 5.39: Fine guide point decrement

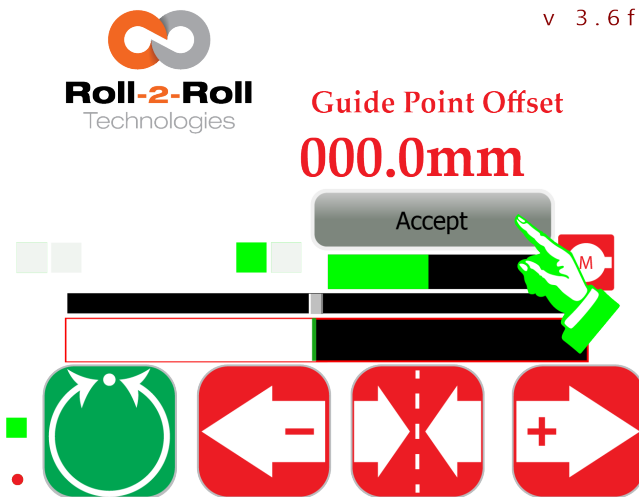


Figure 5.40: Fine guide point increment

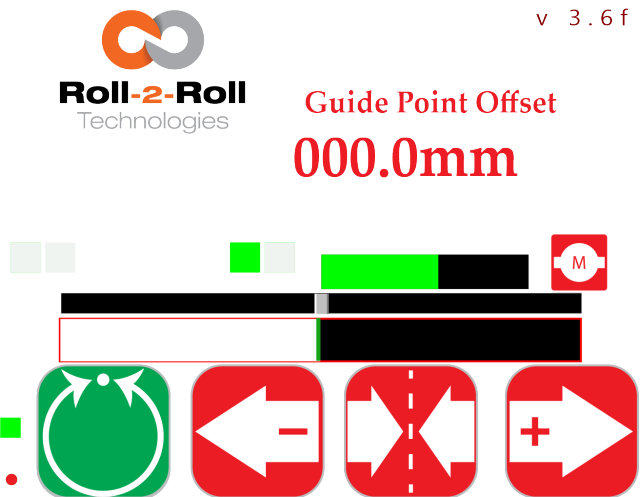


Figure 5.41: Fine guide point decrement

Warning

- Adjusting the guide point can lead to a shift in the web guide's position, potentially causing disruptions in the process. This operation should be approached with caution and only by individuals fully aware of the implications of such adjustments.
- It is advisable to adjust the guide point only when essential and to entrust this task to personnel well-versed in the repercussions of such modifications. If the guide point strays too far from the optimal 50% setting, the performance of the guiding system may suffer. Certain alterations may not have any impact if the web guide is positioned extremely.

5.1.16 Firmware Version

The present firmware version is shown at the top right corner of the home screen, indicating only the major firmware version. For the exact firmware number, one can refer to the label on the back of the controller.

i Info

When seeking technical support from Roll-2-Roll Technologies, it is beneficial to have both the primary firmware version and the precise firmware number on hand for troubleshooting purposes.

5.1.17 Actuator Icon

Pressing the actuator icon will change the display to the operator actuator position screen. Further details regarding the operator actuator position screen can be found in Section 5.2.

5.1.18 Tools Icon

Tapping on the tools icon will bring up the advanced settings menu (featuring a numeric password keyboard) allowing the user to engage in more advanced interactions with the controller. Further details can be found in Section 5.3.

i Info

When the controller is set to automatic mode, this icon will be deactivated to restrict access to the advanced settings menu.

5.2 Operator: Actuator Position Screen

The actuator position screen (see Figure 5.42) is an expanded version of the actuator position bar displayed on the home screen, accessible from the home screen. Operators can remotely adjust the roll-to-roll machine using this screen. They can simultaneously observe the web guide's reaction to the adjustments in real-time.

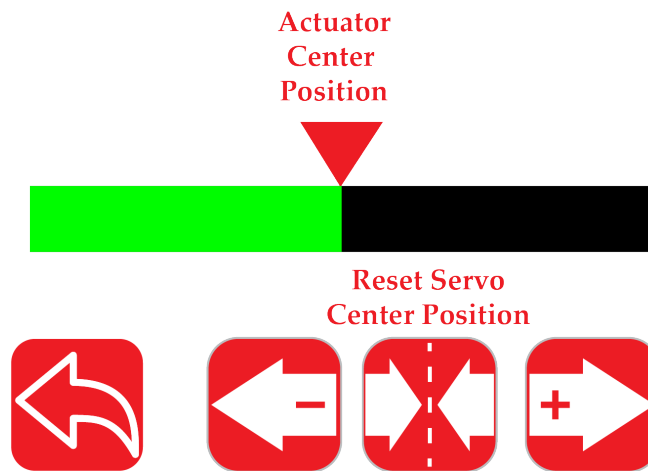


Figure 5.42: Actuator Position Screen

5.2.1 Actuator Position Bar

The actuator position is shown in real-time as the web guide retracts and extends, whether in manual or automatic mode of the web guiding system. The position, orientation, alerts, and warnings are mirrored on the actuator position bar on the home screen.

The expanded view serves specific situations where operators must adjust the guide point of a guide upstream or downstream by referring to the actuator position on the controller. This is done to reduce the overall error propagation within the machine.

5.2.2 Jog Left/Jog Right Icon

When the controller is switched to manual mode on the Home/Main screen, operators have the ability to manually adjust the actuator by utilizing the jog left and jog right buttons provided on this interface.

i Info

The position of the actuator center shown on the screen does not correspond to the actual center position of the actuator or the midpoint of the actuator's stroke. Instead, it represents the servo center position designed to serve as the central position for the web guide mechanism.

5.2.3 Reset Servo Center Position

In some instances, it might be required to make minor modifications to the servo center position to guarantee precise alignment of the rollers on the web guide with the remainder of the machinery. This situation can arise when the point at which the servo center sensor is activated does not correspond precisely to where the web guide frame aligns with all the machine's rollers. In such circumstances, manual relocation of the servo center sensor is necessary. Nevertheless, rather than engaging in the laborious process of manually readjusting the servo center sensor, the icons displayed on this screen can be utilized to digitally fine-tune the adjustment in software.

The Jog Left, Jog Right and Servo Center icons on the bottom of the screen can be used to digitally program the servo center position to be any arbitrary position within the actuator stroke.

Note

This functionality can be used only when the controller is in manual mode.

When the controller is set to manual mode, the Jog Left and Jog Right buttons can be utilized to manually adjust the actuator until the rollers on the web guide mechanism align precisely with the other rollers on the machine, as illustrated in Figure 5.43. If the actuator position bar does not align with the actuator center position indicator triangle, pressing the reset servo center position button will capture the necessary digital offset for fine-tuning the servo center position, as depicted in Figure 5.44. This new position will only be saved upon pressing the "Accept" button, shown in Figure 5.45. Upon pressing "Accept," the controller calculates and stores the digital offset for future servo center operations on the home screen. Once the offset is successfully saved, the actuator position bar will return to the center position, as shown in Figure 5.46.



Figure 5.43: Jog the Web Guide to Center Position

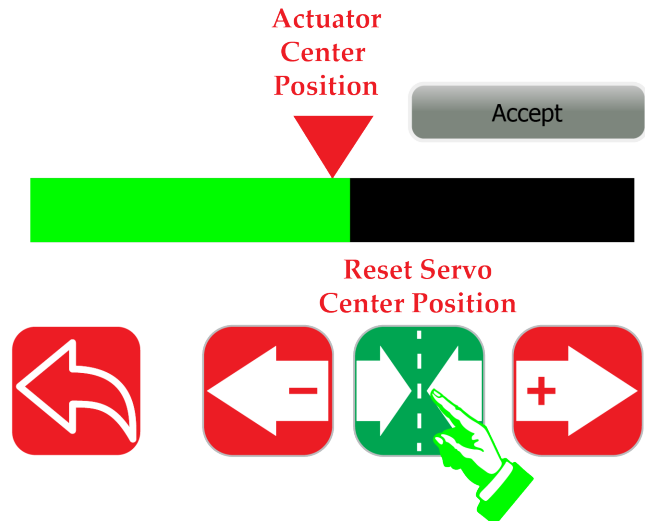


Figure 5.44: Reset Servo Center Position

The functionality operates by capturing the deviation from the current servo center position. When a physical sensor is used to determine the servo center position, the calculated deviation is combined with the digital trigger position of the physical sensor during the servo centering process to establish the fine tuned servo center position. If the software is employed without an actual sensor, the actuator's

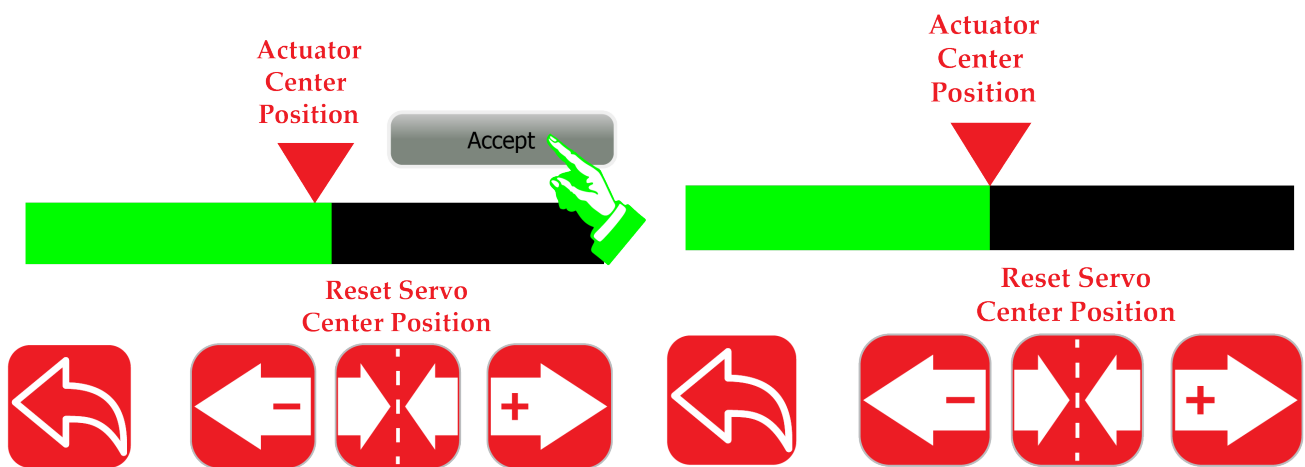


Figure 5.45: Accept the New Servo Center Position Figure 5.46: Save the New Servo Center Position as an Offset

digital step count from the Roll-2-Roll[®] Driver is used instead.

Info

- The option to adjust the servo center position is available on controllers with firmware version v3.6e or later.
- For firmware versions v3.6m and above, the servo center reset functionality will only work when the power user password protection is disabled. See Section 5.18 for more information about password protection.

Note

- It is advisable to execute the servo center operation from the main screen prior to utilizing this screen for resetting the servo center position.
- In case a physical servo center sensor is activated, whenever the reset servo center position button is triggered, the offset is recalibrated using the physical servo center position and the present actuator position.
- If the physical servo center feature is disabled (see Section 5.15.5) to utilize the sensorless software version, pressing the reset servo center position button will reset the offset to zero and set the digital step count on the Roll-2-Roll[®] Driver back to zero.

Warning

- The offset value may become corrupted if this functionality is not used correctly. In such a situation, the offset value must be reset to zero before proceeding with the steps outlined in this section.
 1. To reset the offset value to zero, you can disable the physical sensor based servo center functionality (refer to Section 5.15.5).
 2. Reset the Servo Center Position on this screen (this action will set the offset to zero).
 3. Re-enable the physical sensor based servo center functionality.

5.3 Advanced Settings Menu

The advanced configuration menu provides the opportunity for operators, power users, and maintenance technicians to customize the controller parameters according to their specific requirements. To access this menu, users can simply tap the Advanced Settings icon displayed on the main screen. A detailed illustration of this menu is presented in Figure 5.47.

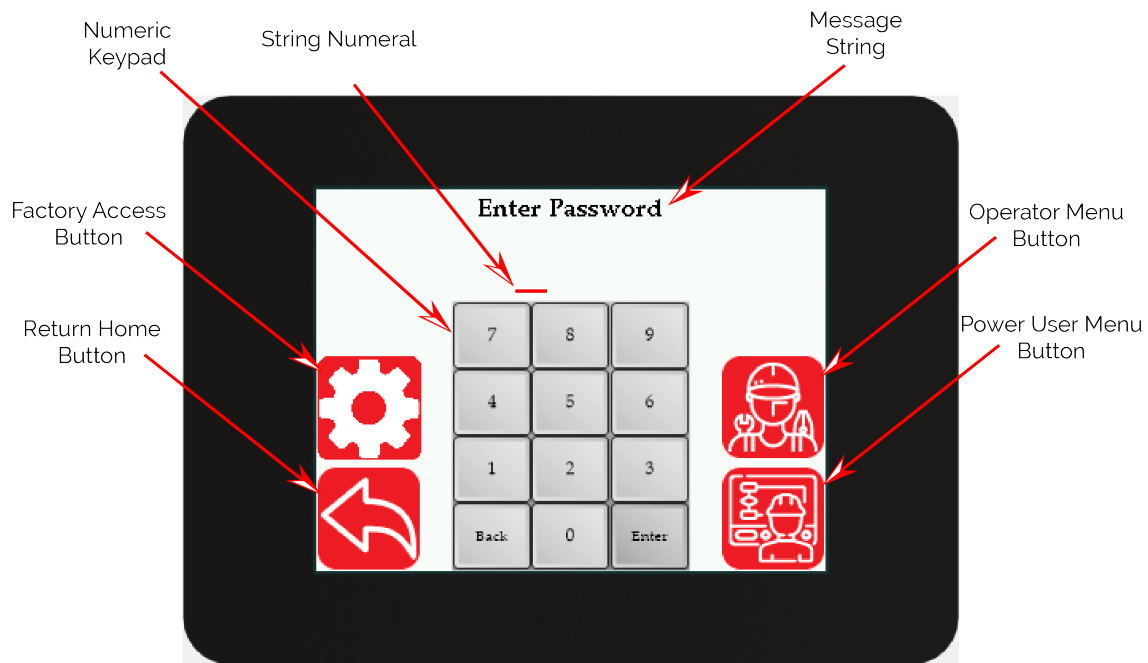


Figure 5.47: Advanced Settings Menu with Optional Password Keypad

Access to the advanced screens can be limited by passwords to prevent unauthorized modifications to the settings by individuals who are not authorized to do so. If a password is needed for access, the access button will not be visible, as illustrated in Figure 5.48.

A four-digit numerical password is required to reveal the corresponding icons. The numeric keypad can be utilized to input the four-digit password. The numerical string will only reveal the last digit, concealing the previous digits, as depicted in Figure 5.49 – 5.51. The "Back" button on the keypad serves as a backspace to erase previous digits. Upon entering all four digits, the "Enter" button on the keypad can be pressed to confirm the password.

If a valid password is input, the relevant access button will become visible, as shown in Figure 5.52. In case of an invalid password, an error message will be displayed at the top, as illustrated in Figure 5.53. The password validation requires all four digits to be entered, and the password string will always be reset after validation.

i Info

There is no need to enter a numeric password if the respective icon is already visible.

Enter Password

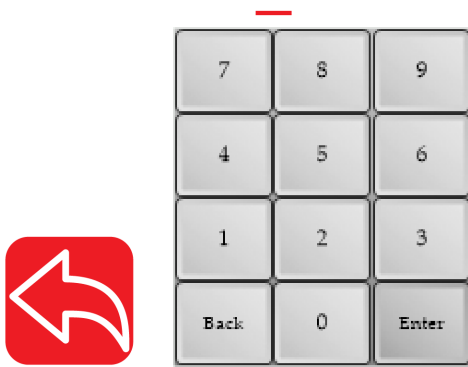


Figure 5.48: Advanced Menus with Password Protection that Requires Numeric Password

Enter Password

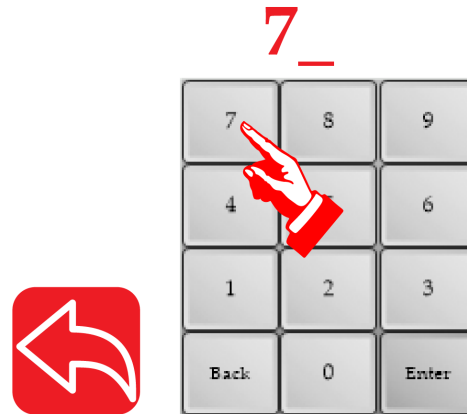


Figure 5.49: Touch Numeric Keypad to Enter Password

Enter Password

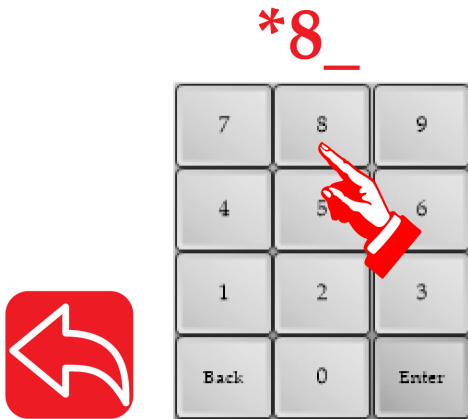


Figure 5.50: Touch Numeric Keypad to Enter Password

Enter Password

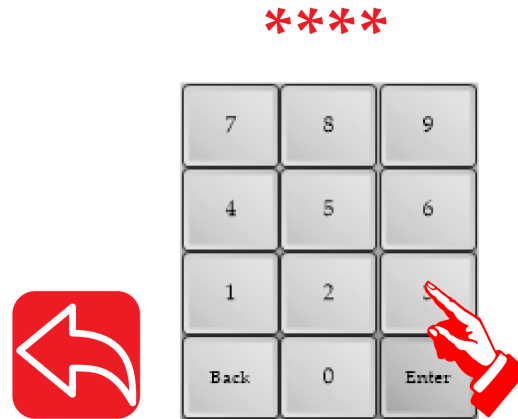


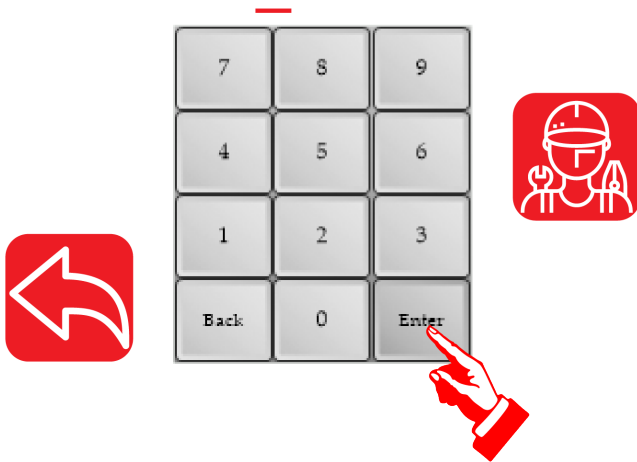
Figure 5.51: Touch Numeric Keypad to Enter Password

Note

The password protection will be turned off by default, and both the operator icon and the power user icon will be displayed.

Procedures to restrict access and to change the factory default password are provided in Section 5.18.

Enter Password



Incorrect Password. Try Again

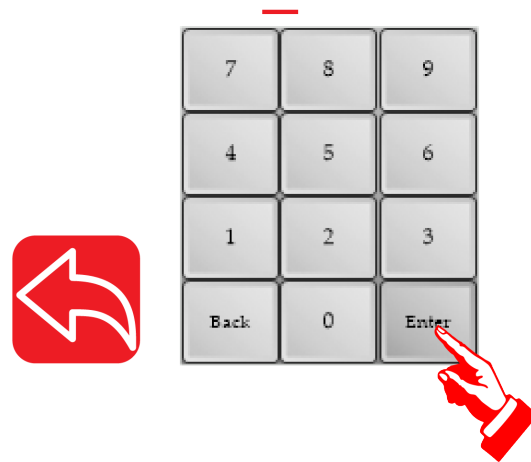


Figure 5.52: Press Enter to Validate Password. Re-

Figure 5.53: Incorrect Password, Resets the Password String for Another Try.

5.4 Operator Menu

The operator menu screen allows operators to access various screens (see Figure 5.54) that are regularly used as part of their daily operational routine. Clicking on any of the icons will take the user to the corresponding screen. By pressing the return button, the user can return to the previous screen of Advanced Setting Menus.

Key screens include the operator sensor screen, the operator width screen, the operator oscillation screen, and the operator flag detection screen. These screens are essential for adjusting job or application parameters related to the sensing, guiding, measurement, and monitoring tasks according to standard operating procedures.

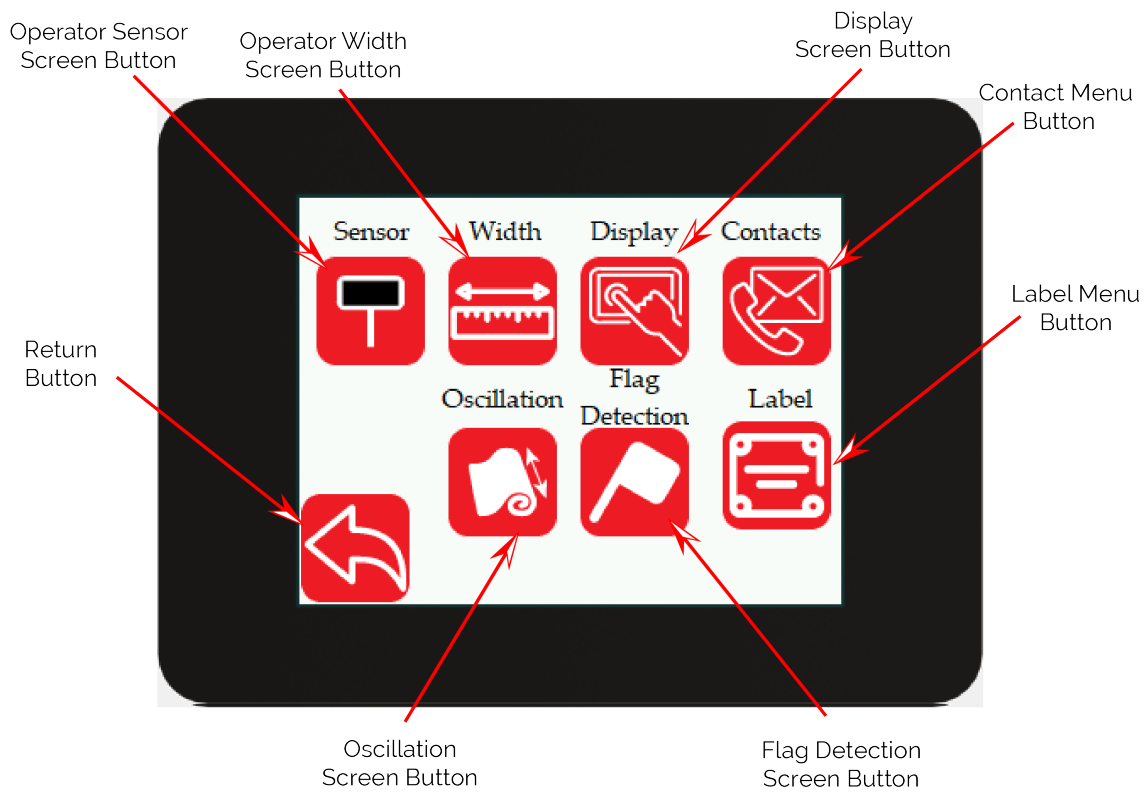


Figure 5.54: Operator Menu Screen

5.5 Operator: Sensor Screen

This screen provides high level access to the user for several functionalities that allow for control of the sensor brightness, the type and parameters of the edge detection algorithm, as well as the contrast/pattern teaching functionalities. Several key parameters, important for the edge detection algorithm, is available on this screen. Hence it is critical that the user is familiar with all the functionality to ensure proper operation of the controller. An annotated image of the user interface is shown in Figures 5.55 and 5.56 with all the different key press options highlighted.

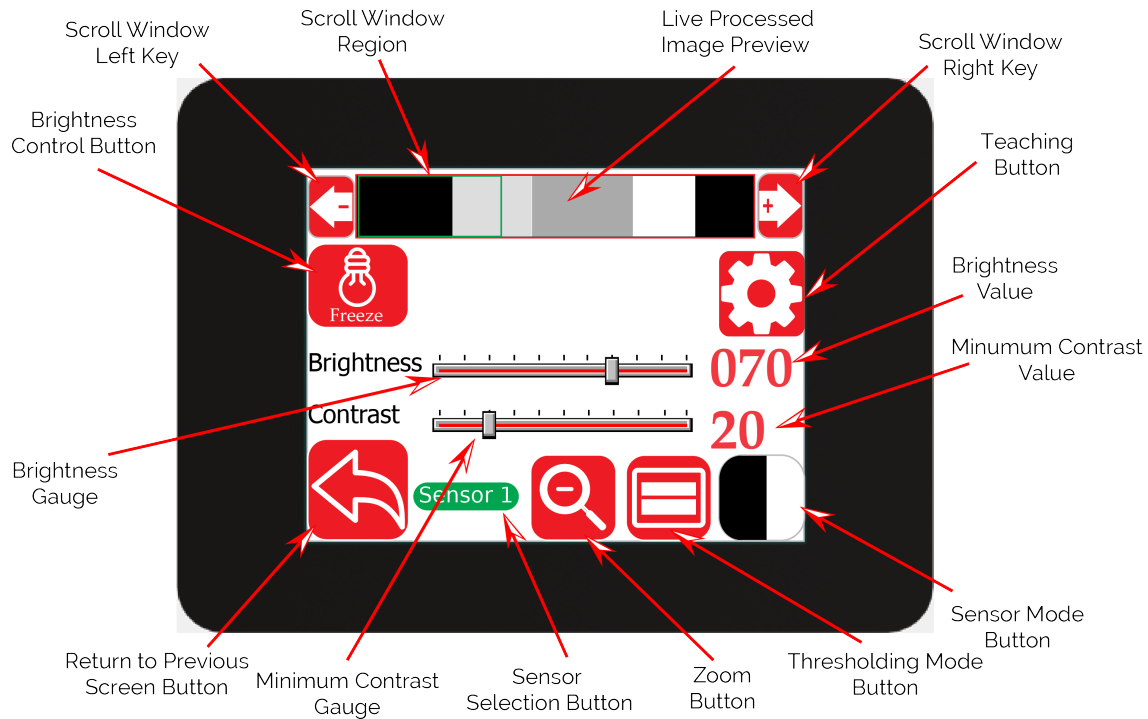


Figure 5.55: Operator Sensor Screen: Edge Mode

Warning

Modifying certain settings on this display can have a substantial impact on the controller's ability to detect edges. Therefore, it is crucial for users to have a good understanding of how these adjustments work and the potential outcomes they may have on the system.

5.5.1 Sensor Mode

The operator has the ability to switch the sensor mode from edge sensing to contrast/pattern sensing by toggling the sensor mode button. The controller is in edge sensing mode when the icon is displayed in black and white (refer to Figure 5.55), while it operates in contrast/pattern mode when the icon is displayed in black, green, and white (refer to Figure 5.56).

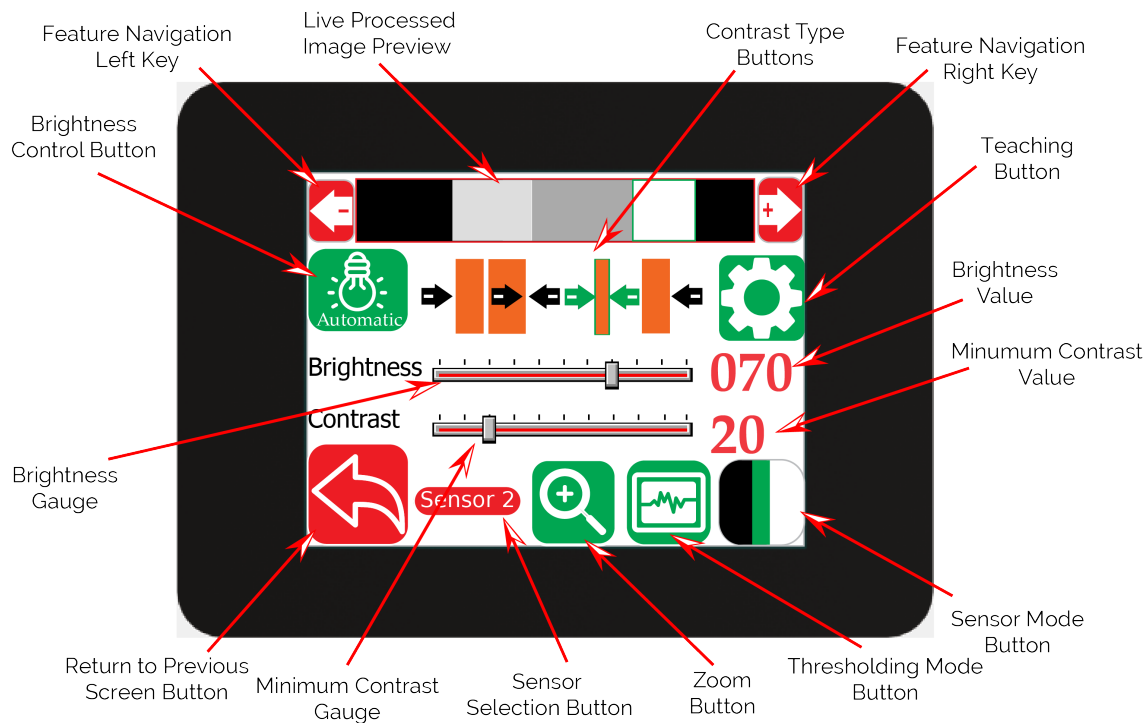


Figure 5.56: Operator Sensor Screen: Contrast Mode

Edge Mode

The edge mode is utilized to identify the boundary of an entity such as webs, strings, wires, threads, sheets, among others. In edge mode, the controller can be programmed to search for the edge in a specific direction determined by the sensor's orientation parameter. For example, if the sensor is configured for a left orientation, the controller examines the image from left to right to detect the first edge (on the left side) in that direction. Similarly, if the sensor is set to a right orientation, the controller scans the image from right to left to identify the rightmost edge in the image. When the orientation is set to the center, the controller identifies both the leftmost and rightmost boundaries to calculate the position of the centerline.

An edge is characterized as the shift from an empty space to the material of the web. Therefore, for edge mode, the sensor must be positioned at a specific distance from both the web edge and any background. For more information on proper installation please see [Sensor Installation recommendations for Web Guiding Applications](#) and [Sensor Installation recommendations for Inspection Applications](#).

Contrast/Pattern Mode

The contrast or pattern mode is utilized to identify and monitor a distinct feature within the field of view of the sensor. This mode is commonly employed for tasks such as monitoring a printed line, mark, or pattern on a web, particularly in applications related to guiding and measuring the width.

When the contrast mode is activated, extra buttons for selecting the specific type of contrast will be

displayed at the top of the screen, as depicted in Figure 5.56. This feature enables users to select and instruct the controller on the preferred contrast or pattern to be followed for various applications.

Info

The fundamental edge detection algorithm also varies slightly depending on the sensor mode.

Note

- *When contrast/pattern mode is selected, additional contrast mode buttons becomes visible for teaching or learning the contrast/patterns.*
- *Switching between the modes will still save/retain the teaching parameters.*

Warning

The sensor mode must be consistent for both sensors. If the mode is adjusted for one sensor, it will be automatically synchronized with the other sensor.

5.5.2 Thresholding Mode

The edge detection algorithm employs two thresholding approaches, namely static and dynamic, to identify edges in the acquired image. Edge detection involves locating points where the image intensity surpasses a set threshold value. The process of determining this threshold value is an integral part of the algorithm and can be carried out either manually by the user (static) or automatically (dynamic).

Note

Different thresholding methods can be chosen for the two sensors.

Static Thresholding

Static thresholding is employed when the button appears red with a flat line, as illustrated in Figure 5.55. In this operational mode, a singular (static) threshold value is applied to identify edges across the complete image. The user manually configures the threshold value using the contrast gauge. Whenever the intensity of the image surpasses the threshold value at a pixel location, a rising edge is identified. Similarly, whenever the image intensity falls below the threshold value at a pixel location, a falling edge is recognized.

Info

Static thresholding is most appropriate for specific scenarios that require maintaining a constant threshold value. Please refer to Roll-2-Roll Technologies to understand the consequences of using this approach.

Note

Static thresholding can be applied in scenarios where the properties of the web (opacity, porosity and reflectivity) remain consistent in various tasks and the background remains constant across all tasks. Even minor alterations in either can lead to variations in the performance of the edge detection

algorithm.

Dynamic Thresholding

When the icon is green as depicted in Figure 5.56, the dynamic thresholding method is utilized. In this scenario, our proprietary edge detection algorithm is employed, where each image may possess a distinct threshold value determined by the dynamic range of the image being captured. Moreover, the threshold value varies within the image, implying that it can alter across different regions of the image depending on the intensity of each specific region. Consequently, the controller can automatically adjust to both the dynamic range of the captured image and the dynamic range within different regions of the image. This capability enables the controller to identify various materials with diverse opacity, porosity, and other characteristics without requiring any configuration or calibration. This feature distinguishes the Roll-2-Roll® Controller from other edge detection systems available in the market.

Info

Dynamic thresholding is recommended for the edge sensing mode.

5.5.3 Sensor Selection

Pressing the sensor selection button would allow the user to access the settings for the respective sensor. The button press will toggle between Sensor 1 (Figure 5.55) and Sensor 2 (Figure 5.56). The parameter values like brightness and contrast, as well as settings such as brightness control, thresholding modes, contrast modes, and zoom, are specific to each sensor.

5.5.4 Minimum Contrast Gauge

The contrast gauge can be utilized to establish the minimum contrast necessary for edge detection, with the associated numerical integer value shown on the right side of the gauge.

The minimum contrast value grants entry to the edge detection algorithm and enables users to adjust its parameters. In dynamic thresholding mode, the controller imposes an extra condition on the contrast variation at the edge, requiring it to reach a specific value for the edge to be considered valid.

Reducing the contrast value increases the controller's sensitivity to minor contrast variations in the sensor-captured image, leading to the detection of more edges with low contrast. Conversely, setting a high contrast value allows the controller to detect edges with high contrast while disregarding those with low contrast.

The suggested minimum contrast value for edge mode is 12, while for contrast mode it is 25.

Note

- *Adjust the minimum contrast to the highest level possible while ensuring that the feature of interest remains discernible. This will enhance the algorithm's robustness.*
- *If the thresholding method is fixed, the minimum contrast setting directly corresponds to a scaled static threshold value.*

- In specific scenarios, users may not have the option to modify the minimum contrast setting. This restriction is applicable in contrast mode, particularly when the controller is programmed to monitor a specific feature on the web.

Warning

- In the case that the sensing mode is set to contrast and the minimum contrast value is low, the contrast detection algorithm will not operate effectively and will detect even minor changes in the image. It is advisable to use a default value of 25 for contrast mode.

5.5.5 Brightness Gauge

The brightness gauge and the numerical value displayed alongside indicate the percentage of LED brightness emitted by the corresponding sensor. In freeze mode, the gauge can be utilized to manually adjust the brightness level, ranging from 0% to 100%. In automatic mode, the indicator reflects the current brightness level. Modifying the brightness setting during automatic mode will reset the automatic brightness control algorithm and display the live updates of brightness on the indicator and numerical display.

Note

Manual adjustment of the brightness setting is designed for advanced users. In most cases, it is preferable to allow the brightness to adjust automatically.

5.5.6 Brightness Control

The controller is equipped with an automated brightness control algorithm that adjusts the brightness of the sensor's LEDs according to the captured image. This algorithm is designed to optimize image quality based on specific criteria and assist in background suppression. Users have the option to deactivate the automated brightness control to manually adjust the LED brightness. By pressing the brightness control button, users can switch between automatic mode and manual control.

When the manual mode is activated, the icon will change its color to red and display "Freeze." Conversely, if the automatic brightness control is switched on, the icon will turn green and show "automatic."

Note

This functionality is designed for advanced users, and the default setting should enable automatic adjustment of the brightness control.

5.5.7 Live Processed Image Preview

The rectangular box at the top displays a live preview in grayscale of the processed image captured by the sensor. Various levels of contrast captured by the sensor are represented as rectangles in the image preview. Regions on the web that reflect a minimal amount of light back to the sensor will appear dark

or black, whereas regions reflecting more light will appear light or white. The grayscale value indicates the average intensity of light within each specific region between the detected edges.

Info

This preview displays the processed image rather than the original image captured by the sensors. Initially, the processing involves identifying all the edges in the image, represented by vertical red lines. Subsequently, the average intensity between these edges is illustrated as the grey area enclosed by them.

Modifying parameters like brightness, contrast, thresholding mode, sensor mode, and zoom state will display the instant impact on the processed image within the live preview area.

5.5.8 Feature Navigation Left/Right

The live processed image preview allows users to navigate through it using the left and right arrow keys to choose the desired contrasting feature. When a contrast mode is selected, these keys can be used to shift either the chosen edge or line to the left or right.

Note

The feature selection key can be used only when the controller is in contrast teaching mode.

5.5.9 Selected Feature

The controller has the capability to learn how to follow a specific characteristic by utilizing one of the contrast modes. Throughout the teaching process and subsequently, the identified feature being followed is indicated by a green bounding box. The shape of the bounding box, whether it is a rectangle, a three-sided rectangle, or two three-sided rectangles, varies depending on the contrast mode in use.

Note

The selected feature bounding box is only visible when in contrast mode. If the feature being taught is not detected within the sensor's range, bounding boxes will not be displayed, indicating an invalid contrast condition.

5.5.10 Teaching

When the controller is in the contrast teaching mode, the gear icon will appear green (see Figure 5.57). The user can press the left and right feature navigation keys to navigate to the feature of interest. To save the teaching, so that the controller can follow the feature of interest, the gear icon can be pressed again. Successful teaching and saving of the feature of interest will turn the gear icon to red and all the contrast mode icons will disappear, except for the selected contrast mode as shown in Figure 5.58. The selected contrast type and the selected feature will be highlighted appropriately.

Note

Teaching is only possible when the sensor mode is contrast.

Warning

When teaching, the controller will search for the initial occurrence of the desired feature either from left to right or right to left, depending on the sensor's orientation. In cases where two features with identical conditions are present within the sensor's field of view, the feature on the far left will be chosen for left orientation and vice versa. It is advisable to teach using a distinct feature within the sensor's view to enhance the accuracy of the measurement.

5.5.11 Contrast Type

There are four distinct contrast modes for users to choose from when the controller is in teaching mode. These options consist of the right edge of a color (or grayscale), an edge formed by two colors, the location of a line with a specific color and specific width, and the left edge of a particular color. Once a mode is chosen, the area of interest is highlighted in the icon as depicted below. After successfully saving the teaching process, the icon associated with the selected mode will be displayed on the screen, while the icons for the other three modes will disappear.

Right edge of a color

In this operating mode, the controller will search for the right edge of a user-defined color (or grayscale) as illustrated in Figure 5.57. A three-sided open rectangle will outline the area of interest with the right edge of the colored area highlighted in green. Users can use navigation arrows to move to the area of interest. Upon highlighting the desired area of interest, the teaching can be saved by clicking on the gear icon. After saving the teaching, all other modes will be deactivated, and the gear icon will change to red as depicted below in Figure 5.58.

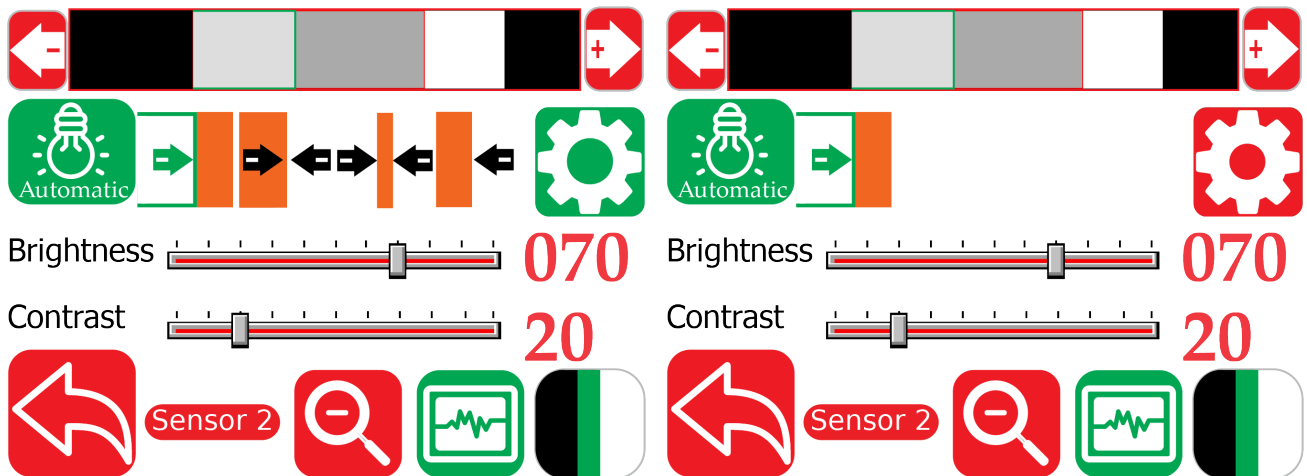


Figure 5.57: Right edge of a color (Teaching)

Figure 5.58: Right edge of a color (Teaching Saved)

Note

- In the scenario described above, the user is unable to move to the rightmost area because the controller does not detect an edge in that color.
- Upon successful saving of the teaching, as confirmed by the absence of all other mode icons, the user is restricted from modifying the brightness control state, the brightness gauge, or the minimum contrast gauge.

Warning

If multiple features share the same color, the controller will select only the initial right edge based on the sensor's orientation. It is advised against utilizing this mode when two web features have identical colors; employing line mode or creating an edge with two colors might be a preferable alternative.

Edge created by two colors

In this mode, the controller will seek an edge formed by a specific color on the left and another specific color on the right. Two areas will be highlighted, together with the particular edge of interest, as depicted in Figure 5.59. The controller will search for the initial occurrence of a precise match of the edge with the two designated colors on each side in the correct sequence. Because all three criteria must be met, this mode is considered highly reliable. Once the instruction is stored, all other modes will vanish, and the gear icon will change to red, as illustrated in Figure 5.60.

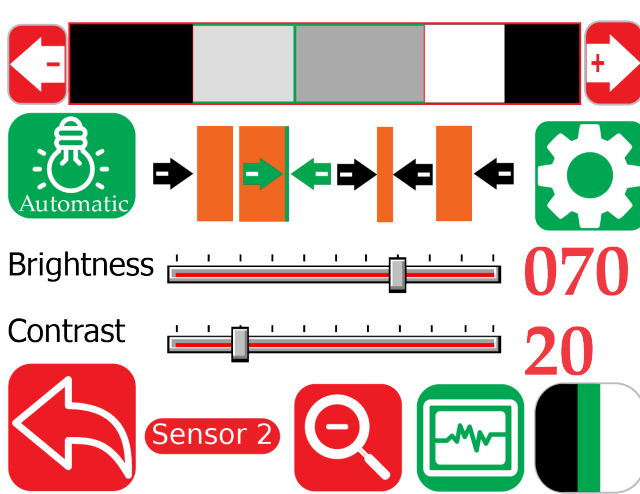


Figure 5.59: Edge created by two colors (Teaching)

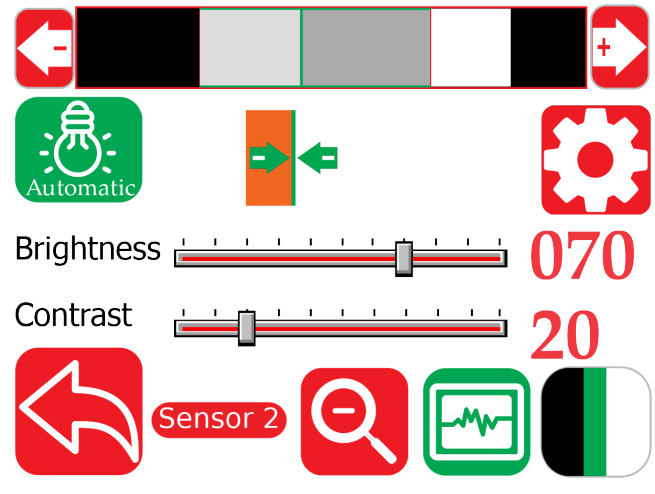


Figure 5.60: Edge created by two colors (Teaching Saved)

Note

- The sequence of colors is significant in this mode. The controller does not select an edge based on the two adjacent colors; it only does so when the orientation of the neighboring colors aligns with the condition saved during teaching.
- In cases where multiple regions exhibit identical color pairs (e.g., in a barcode), the controller

consistently opts for the initial pair according to the sensor's orientation direction.

- Upon successful saving of the teaching, signified by the removal of all other mode icons, the user is unable to modify the state of brightness control, the brightness level indicator, or the minimum contrast level indicator.

Color and width of a line

In this operating mode, any area bounded by two edges can serve for tracking purposes. The controller will seek to fulfill two criteria for tracking the line feature: (1) its color and (2) the width of the colored area (see Figure 5.61). Because both criteria must be met, this mode is considered highly reliable. Upon saving the settings, all other modes will be deactivated and the gear icon will change to red (see Figure 5.62). Following the saving of settings, the controller will consistently select the initial instance of the specified color with a particular width when scanning in the same direction as the sensor's orientation.

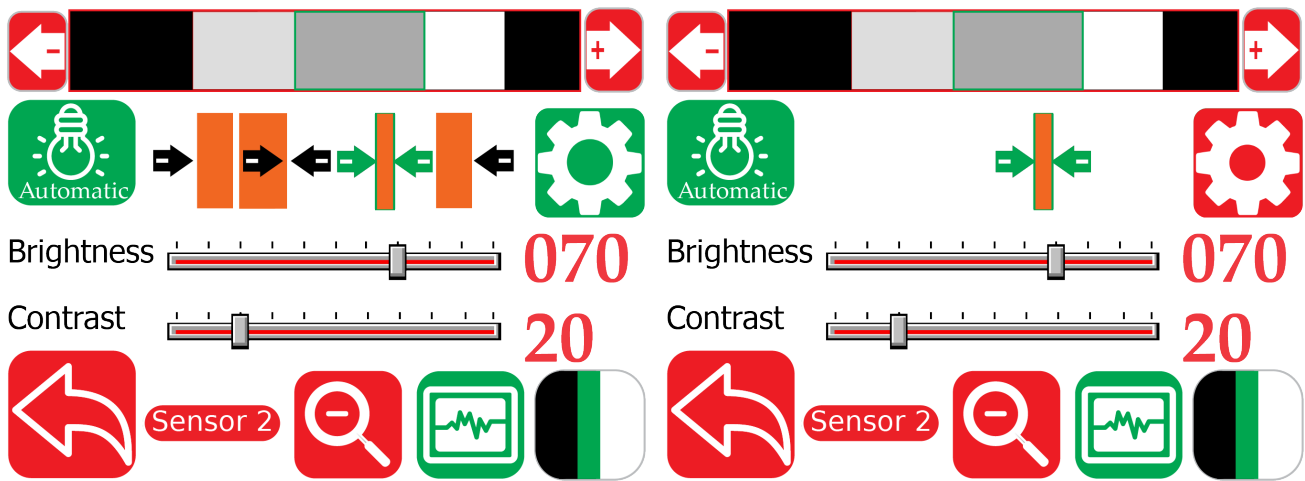


Figure 5.61: Color and width of line (Teaching)

Figure 5.62: Center of a line (Teaching Saved)

Info

While tracking the line, the actual position that the controller is tracking is the center of the line or the middle position between the two edges of the line.

Note

In the example provided, the user is unable to access the far-right or far-left areas because the controller lacks visibility of both edges of that particular color. To enable the controller to secure the line feature, both edges of a specific color must be visible.

Warning

If two lines have identical width and color, the controller will consistently select the first matching line in the direction corresponding to the sensor's orientation.

Left Edge of a color

Just like tracking the right edge of a color, this function enables users to track the left edge of a specific color. When in teaching mode, a rectangular area of interest and its left boundary will be emphasized, as illustrated in Figure 5.63. After selecting the desired area, users can save the teaching by clicking on the gear icon, depicted in Figure 5.64. Upon successful saving, all other modes will be deactivated, and the gear icon will change to red.

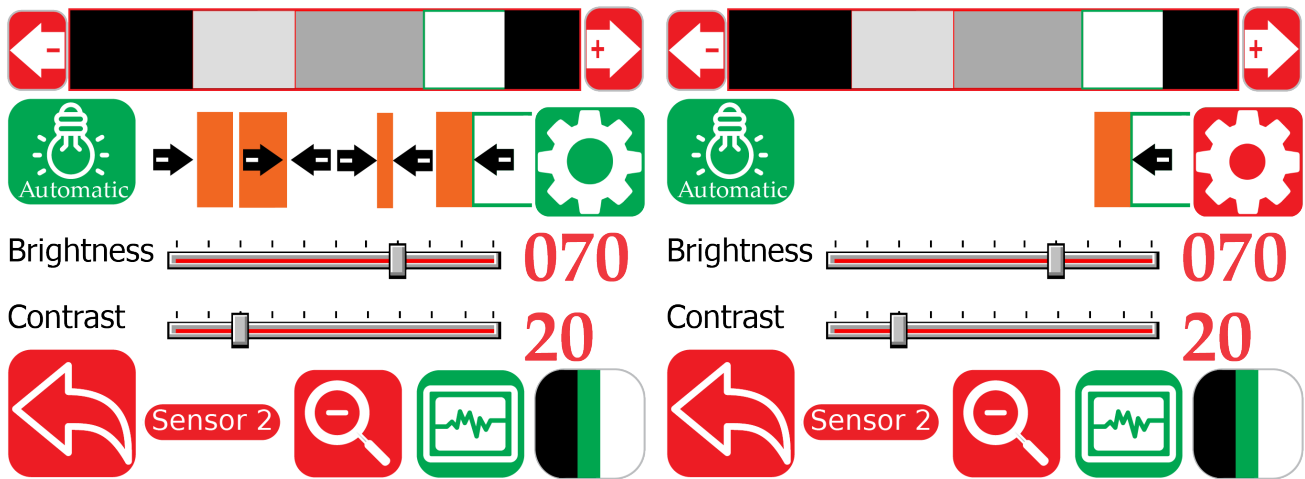


Figure 5.63: Left edge of a color (Teaching)

Figure 5.64: Left edge of a color (Teaching Saved)

Note

In the example provided, the user is unable to access the far-left area because the controller lacks visibility of left most edge of that particular color. To enable the controller to secure feature, left edge of a specific color must be visible.

Warning

If two regions have identical color, the controller will consistently select the first matching line in the direction corresponding to the sensor's orientation.

Additional information about contrast mode

Info

- During teaching, the controller will refrain from scrolling through a region if the feature in that particular mode is not adequately defined. For instance, when in a left edge of a color mode the user is unable to select and teach for the leftmost region since the leftmost edge must fall within the sensor's viewing area. Likewise, in line mode, the controller will not select the leftmost or rightmost region as both edges must be visible within the sensor's viewing area for a line.
- If the feature of interest is not within the sensor's field of view, no region will be highlighted, a scenario known as the "No Contrast" condition.

- The no contrast condition is only applicable when the teaching is saved and if the taught feature is not visible in the sensor's field of view.
- In automatic mode for web guiding, the web guide will switch to an interlock mode and prevent the actuator from moving whenever a no contrast condition is detected. Once the feature of interest reappears, the web guide will activate if the feature's position is not at the desired guide point.
- In the event of a no contrast condition, the analog output will provide the midpoint value of its output range. The digital output via ethernet will correspond to the total number of pixels in the sensor. Under normal circumstances, the digital contrast position output will vary between zero and (number of pixels - 1). A value equal to the number of pixels indicates a no contrast condition.

Warning

If the teaching is not successful or if an invalid feature is picked, then all four icons will be visible on the screen. Successful teaching will make three mode icons disappear, while leaving the chosen one visible. At the same time, the gear icon would change from green to red.

5.5.12 Scroll Window Left/Right

Starting with firmware version 3.6n, a new feature has been added for scroll window functionality (refer to the following section for additional information). While in edge mode, the scroll window's left and right keys allow users to shift the scroll window area in either direction by pressing the corresponding key.

Note

The scroll window area will be visible only in edge mode. At first, the scroll window will be inactive and will only show up when the left or right arrow key for the scroll window is pressed.

5.5.13 Scroll Window Region

Beginning from version 3.6n of the firmware, a new scroll window functionality has been introduced. In edge mode, users can navigate to a specific region of interest by utilizing the scroll window's left and right keys located adjacent to the live processed image preview. This scroll window region is indicated by a green rectangle superimposed on the live processed image preview as shown in Figure 5.55. Each time the Scroll Window Left/Right button is pressed, the window will shift by 50 pixels. The window always has a size of 768 pixels, and its dimensions vary depending on the sensor type, being either 48.768 mm (1.92 in) or 97.536 mm (3.84 in).

Note

The scroll window area will be visible only in edge mode. At first, the scroll window will be inactive and will only show up when the left or right arrow key for the scroll window is pressed.

5.5.14 Zoom State

Starting from firmware version 3.6n, this function enables users to select and manipulate the image captured in the scroll-window area. Users can navigate to a particular area of interest in edge mode by using the left and right arrows of the scroll window and the scroll-window region when the zoom state is red or unzoomed, as shown in Figure 5.65. By pressing the zoom state button, users can activate the selective processing of the image within that scroll-window section. Once the button changes to green, a live preview of the processed image will be displayed zoomed in to the chosen region of interest (as depicted in Figure 5.66).

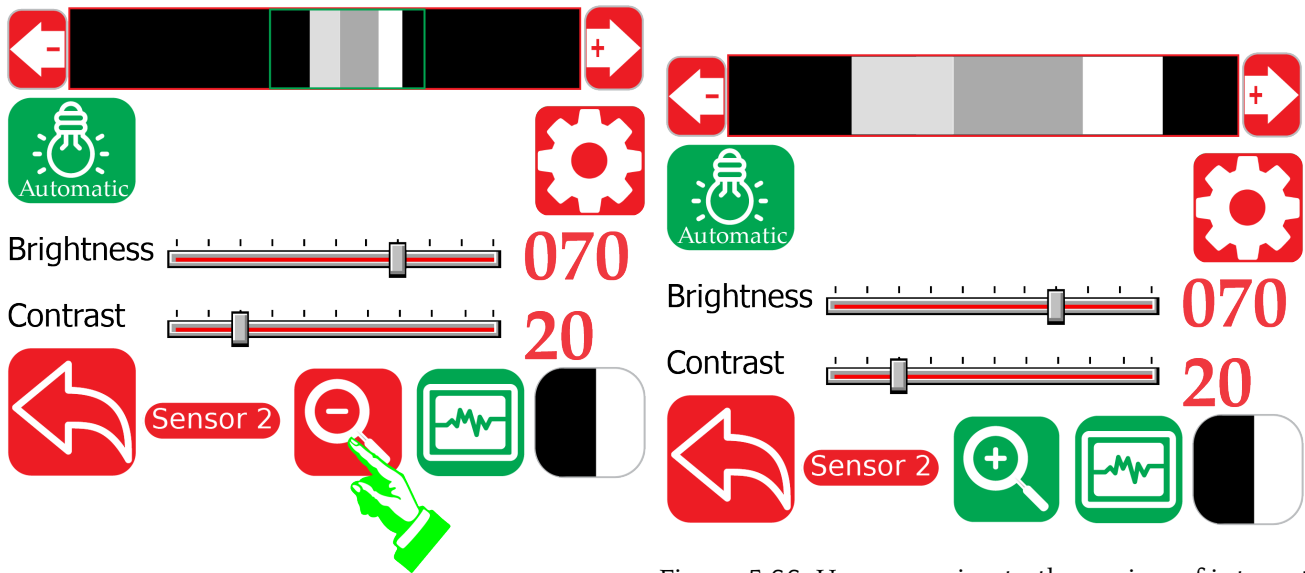


Figure 5.66: User zooming to the region of interest

Figure 5.65: User scrolling to the region of interest

Info

This functionality is intended for use in contrast mode alongside a wide sensor. Rather than trying to analyze the entire wide image, the user can choose to have the controller process only the specific smaller area of interest. Moreover, when the feature of interest for tracking in contrast mode is significantly smaller than the field of view of the sensor, this selective processing enables the user to zoom in on the area and identify the feature of interest more effortlessly.

Note

- When the zoom status is green (enlarged) and the sensor mode is edge, the Scroll Window Left/Right icons remain functional for the user. In this situation, the zoomed image will scroll directly instead of displaying a Scroll Window Region. It is important to highlight that using the Scroll Window Left/Right buttons will cause the window to scroll in the respective direction, resulting in the live preview of the processed image moving in the opposite direction.
- If the user exits this screen while in edge mode, the zoom level will revert to its original unzoomed state always since this mode is only applicable in contrast mode.
- When the zoom status is green (enlarged) and the sensor mode is contrast, the user will lose

the ability to adjust the Scroll Window Region through the Scroll Window Left/Right buttons. Instead, these buttons will function as the Feature Navigation Left/Right button utilized in the contrast mode.

5.6 Operator: Width Screen

To facilitate width measurement tasks, operators can prepare the job by accessing the width screen through the operator menu screen as detailed in Section 5.4.

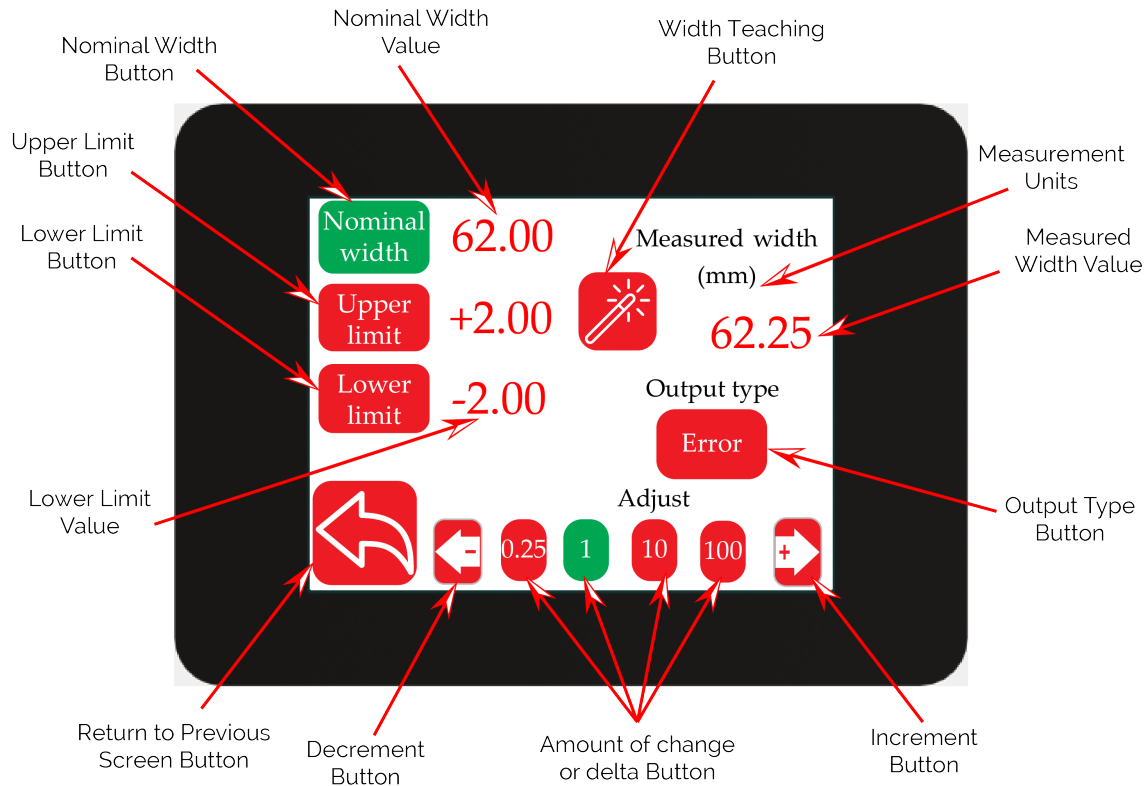


Figure 5.67: Operator Width Screen in mm

The width measurement can be conducted using either one or two sensors to determine the width of a web or the width of contrasting feature(s) on the web. Typically, the width of a web is measured by capturing the two edges visible to a single sensor (in center mode) or two sensors (one on the left and the other on the right).

This screen is primarily utilized in turnkey applications, where a response is triggered by the measurement and the configurations set on this screen. For example, the operator can set the job for a specific width along with defining upper and lower limits for the measurement. This will activate an alarm output if the web width exceeds the upper limit from the set nominal width or falls below the lower limit. A detailed description of the various items on this screen is described in the following.

Note

In order to use the functionality for web width measurement, the analog output in Section 5.17.1 should be set to width mode and the sensor(s) should be appropriately configured.

5.6.1 Nominal Width

The operator has the ability to set a nominal width for each job by activating the nominal width button. When the button is illuminated in green, the operator can adjust the nominal width by utilizing the decrement button (left arrow) and increment button (right arrow) located at the lower part of the display. By selecting a specific change or delta value (pressing the corresponding magnitude value will illuminate the button in green), each press can modify the value by the chosen amount. As the nominal width is changed, the numerical value is shown in the nominal width value. The units for all the parameters on this screen is either millimeter or inch and is shown on the right side.

Info

Given that the sensor's measurements are in pixels and the minimum pixel resolution is 0.0635 mm (0.005 in), the nominal width value will always be a certain specific multiples of the sensor resolution.

Note

- The nominal width can be adjusted from a minimum of 1 mm (0.04 in) to a maximum of 9750 mm (383.85 in).
- For the purpose of enhancing usability, the width value could be approximated to one decimal point once it exceeds a specific threshold. This approximation is solely for presentation and does not affect the precise value utilized for the nominal width.

5.6.2 Upper Limit

The operator has the ability to set a upper limit for each job by activating the upper limit button. When the button is illuminated in green, the operator can adjust the upper limit value by utilizing the decrement button (left arrow) and increment button (right arrow) located at the lower part of the display. By selecting a specific change or delta value (pressing the corresponding magnitude value will illuminate the button in green), each press can modify the value by the chosen amount. As the upper limit is changed, the numerical value is shown in the upper limit value. The units for all the parameters on this screen is either millimeter or inch and is shown on the right side.

When the measured web width is more than the nominal web width then the width error is positive. When the width error is more than the set upper limit value a digital output (corresponding to the upper limit) can be triggered from the controller. If the error is equal to the upper limit or below the upper limit, no fault signal would be generated for the corresponding output.

Info

Given that the sensor's measurements are in pixels and the minimum pixel resolution is 0.0635 mm (0.005 in), the upper limit value will always be a certain specific multiples of the sensor resolution.

Note

The minimum value for the upper limit that can be set is +1 mm (0.04 in) and the maximum value is +99.75 mm (3.92 in).

 **Warning**

The controller will not check to see if the upper limit is more than the nominal width.

5.6.3 Lower Limit

The operator has the ability to set a lower limit for each job by activating the lower limit button. When the button is illuminated in green, the operator can adjust the lower limit value by utilizing the decrement button (left arrow) and increment button (right arrow) located at the lower part of the display. By selecting a specific change or delta value (pressing the corresponding magnitude value will illuminate the button in green), each press can modify the value by the chosen amount. As the lower limit is changed, the numerical value is shown in the lower limit value. The units for all the parameters on this screen is either millimeter or inch and is shown on the right side.

When the measured web width is less than the nominal web width then the width error is negative. When the width error is less than the set lower limit value a digital output (corresponding to the lower limit) can be triggered from the controller. If the error is equal to the lower limit or above the lower limit, no fault signal would be generated for the corresponding output.

 **Info**

Given that the sensor's measurements are in pixels and the minimum pixel resolution is 0.0635 mm (0.005 in), the lower limit value will always be a certain specific multiples of the sensor resolution.

 **Note**

The minimum value for the lower limit that can be set is -1 mm (0.04 in) and the maximum value is -99.75 mm (3.92 in).

 **Warning**

The controller will not check to see if the lower limit magnitude is more than the nominal width.

5.6.4 Measured Width

The measured width provides a real-time width value based on the image captured by one or two sensors. When one sensor is used (in center configuration) the measured width value displayed is the raw measurement from the sensor plus any offset or correction added to the measurement. When two sensors are used (one sensor in left and the other in right configuration), the measured width value displayed is the sum of the raw measurements from each sensor plus any offset. Offset is often necessary when the width is measured with two sensors. Since the controller does not know the actual distance between the two sensors, the offset is necessary to compute the measured width based on the raw width measurement from the sensor(s).

 **Note**

The measured width will update only with correct settings. For example, if one sensor is connected and the sensor is set to left mode, the measured width value will not update. This can be used a troubleshooting to ensure that the controller is set properly to measure the web width.

One Sensor

When utilizing a single sensor for measuring the width, it is essential that the sensor possesses sufficient width coverage to detect both edges of the web, even if the web deviates laterally (horizontally). The sensor should be set in edge mode, configured to center mode to ensure visibility of both edges. The width measurement comprises the original width in addition to an offset. The offset remains applicable for a single sensor, its value may be relatively minor. This offset is employed to account for variations in working distance and focus adjustments according to the sensor's positioning distance from the web.

Note

Measuring the width is also achievable in contrast mode using a single sensor, which represents a more sophisticated scenario. For further information on setting up such a configuration, it is advisable to seek guidance from the Roll-2-Roll Technologies for more comprehensive documentation.

Two Sensors

When utilizing two sensors for width measurement, it is essential to ensure that each sensor is positioned correctly, with one sensor detecting the left edge of the web and the other sensor detecting the right edge. In most cases, the sensors should be set to edge mode. The measurement obtained from each sensor represents the portion of the web visible to that sensor, which is referred to as the raw width. If the two sensors are precisely aligned, their combined readings would correspond to the width of the web. However, if there is an overlap or a gap between the sensors, the offset could be either negative or positive. Therefore, the total measured width would be the sum of the web width detected by each sensor along with the offset.

Note

- *If both sensors are oriented in the same way, the width measurement would still work. However, on the home screen, both edges would appear to be moving in the same direction, creating a black gap in the center.*
- *If the sensing mode is set to contrast, it is necessary to position the two sensors in a specific manner to obtain the accurate measurement of contrast width. For further information on setting up such a configuration, it is advisable to seek guidance from the Roll-2-Roll Technologies for more comprehensive documentation.*

5.6.5 Teaching

Teaching is a crucial step that is essential when the operator initiates each new job. This step is vital for enhancing the precision of the measurement, particularly when the system is expected to provide higher resolution and accuracy. The primary goal of the teaching process is to adjust the system to the new web material. This can be achieved by passing a web of a specified width in front of the sensor under typical operating conditions and teaching the controller the actual web width.

The indicated nominal width value will be utilized in the teaching procedure and will serve as the actual web width. Upon pressing the width teaching button, the controller will automatically determine the deviation by subtracting the current measurement from the sensor(s) at that moment from the

actual web width. The teaching process will only be finalized once the user hits the accept button (refer to Figure 5.68). The controller will calculate the average of the raw values throughout the teaching phase and utilize it to derive the deviation based on the specified width. The calculation of the average begins when the user clicks the teach button and will persist until the user clicks the accept button. After the acceptance of the teaching, this deviation will be automatically incorporated into the raw measurement, and the total width with the correction will be displayed in the measured width section of the screen.

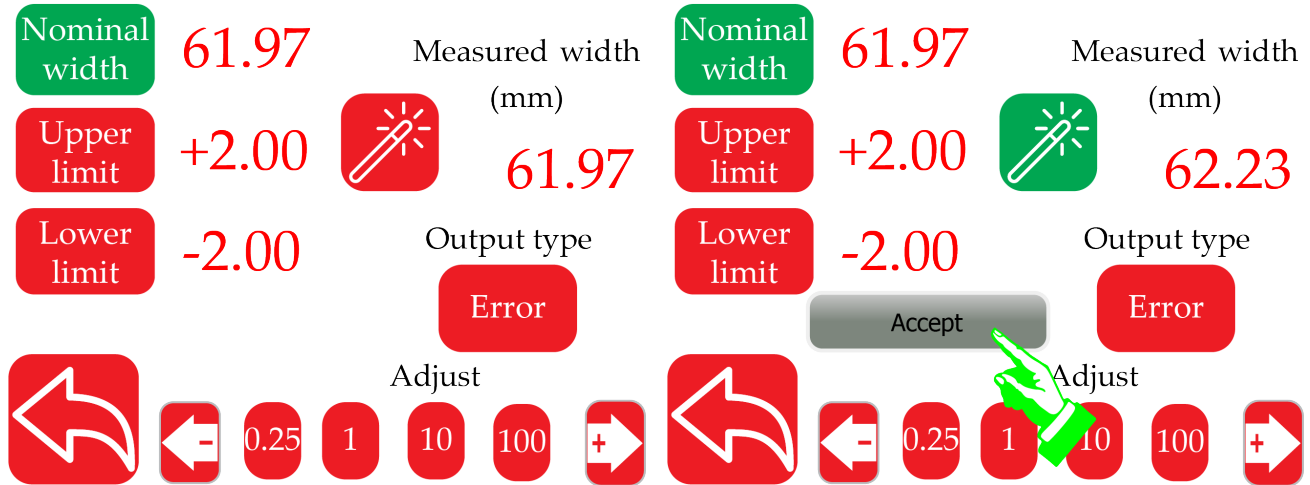


Figure 5.68: Teaching accepted by pressing the accept button

Figure 5.69: Once teaching is accepted the offset is applied to the measured width value

Info

It is unnecessary to repeat the teaching process when adjusting the web width, provided that the web material, web tension, and sensor installation remain unchanged.

Note

- When the teaching wand is activated, the controller will calculate the offset using the following formula: $offset = nominal\ width - raw\ average\ measurement\ obtained\ from\ the\ sensor(s)$. Although the offset value is not displayed, the measured width will be displayed instead. As the measured width is the sum of the offset and the raw sensor measurement, it will match the nominal width if the web is not moving.
- The offset can be reset to zero by pressing the teaching wand when no web is in front of the sensor(s).

5.6.6 Output Type

When an analog output is used for width measurement, the analog output type can be either the absolute measurement of the width or the error between the nominal and measured width. Pressing the output type button will toggle the state between absolute and error outputs.

Absolute

When the setting is adjusted to absolute, the digital width measurement shown on the main screen will present the measured width value in millimeters (or inches). In contrast, the analog output will be adjusted to span from zero to maximum scale based on the sensor's range and the analog output range. For instance, with a 48 mm sensor, a web width of 24 mm would correspond to an analog output of 5 V if the analog output range is configured from 0 to 10 V. However, the same 24 mm width for a 112 mm sensor would result in an analog output of 2.14 V when the analog output range is set to 0 to 10 V. For more information about the analog output please refer to Section 5.17.

Error

When the output is configured to error mode, the digital width measurement shown on the main screen will indicate the discrepancy between the measured width value and the nominal width value in millimeters (or inches). In contrast, the analog output will be adjusted to span from zero to full-scale depending on the error. In cases where the error is zero, the analog output will precisely be half of the full-scale range. For instance, in a scenario where the analog output range is 0 to 10 V, the output will be 5 V when the error is zero. If the error is positive, the output will exceed 5 V, and if the error is negative, the output will be less than 5 V. For more information about the analog output please refer to Section 5.17.

5.7 Operator: Display Screen

The brightness of the controller can be adjusted using the slider on this screen. Additionally, the display units can be changed from millimeter to inch by pressing the display units icon.

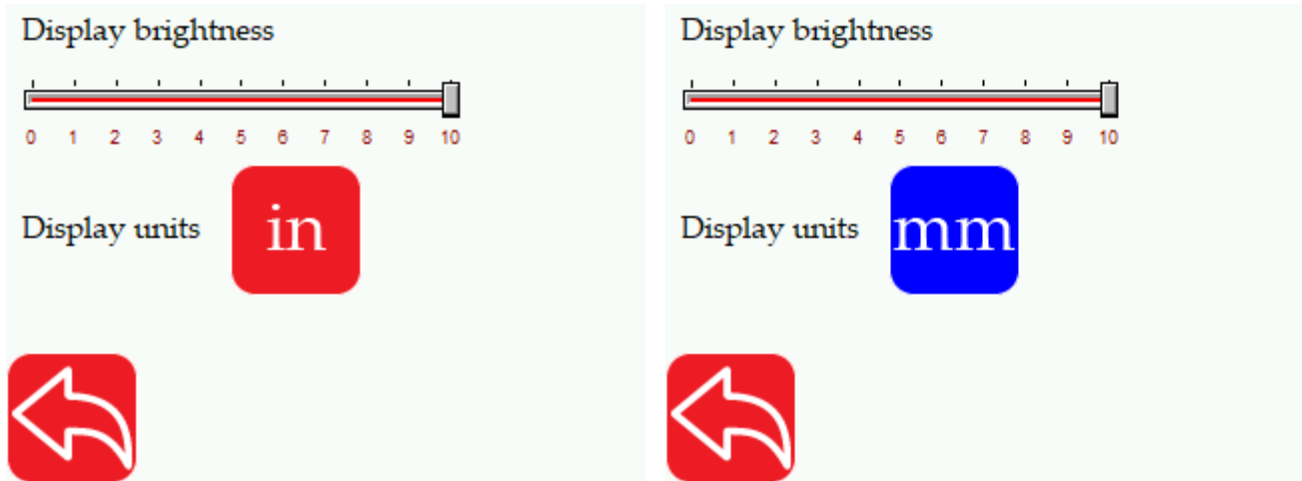


Figure 5.70: Operator Display Screen with inch units

Figure 5.71: Operator Display Screen with millimeter units

Note

The physical units used for measuring web width, guide point offset, and actuator settings screen may vary depending on the chosen display units. The real-time numerical display of measurements will typically show the corresponding unit and the measured value.

5.8 Operator: Contact Screen

The screen displays the contact details for technical assistance, including the website URL, email address, and phone number, for informational purposes and easy access.



Figure 5.72: Contact Information

5.9 Operator: Oscillation Screen

In this menu, users can set parameters for applications that require closed-loop oscillation of the guide point or open-loop oscillation of the actuator.

Info

Oscillation in a web guiding system involves the deliberate side-to-side movement of the web along a defined path. This process is often essential in various industries to improve the quality and consistency of products by avoiding the formation of gauge bands. The oscillation can be carried out in an open-loop manner, where the web guide actuator moves the web back and forth without actively adjusting its position. Alternatively, it can be performed in a closed-loop system where the edge position is monitored and adjusted to predetermined locations.

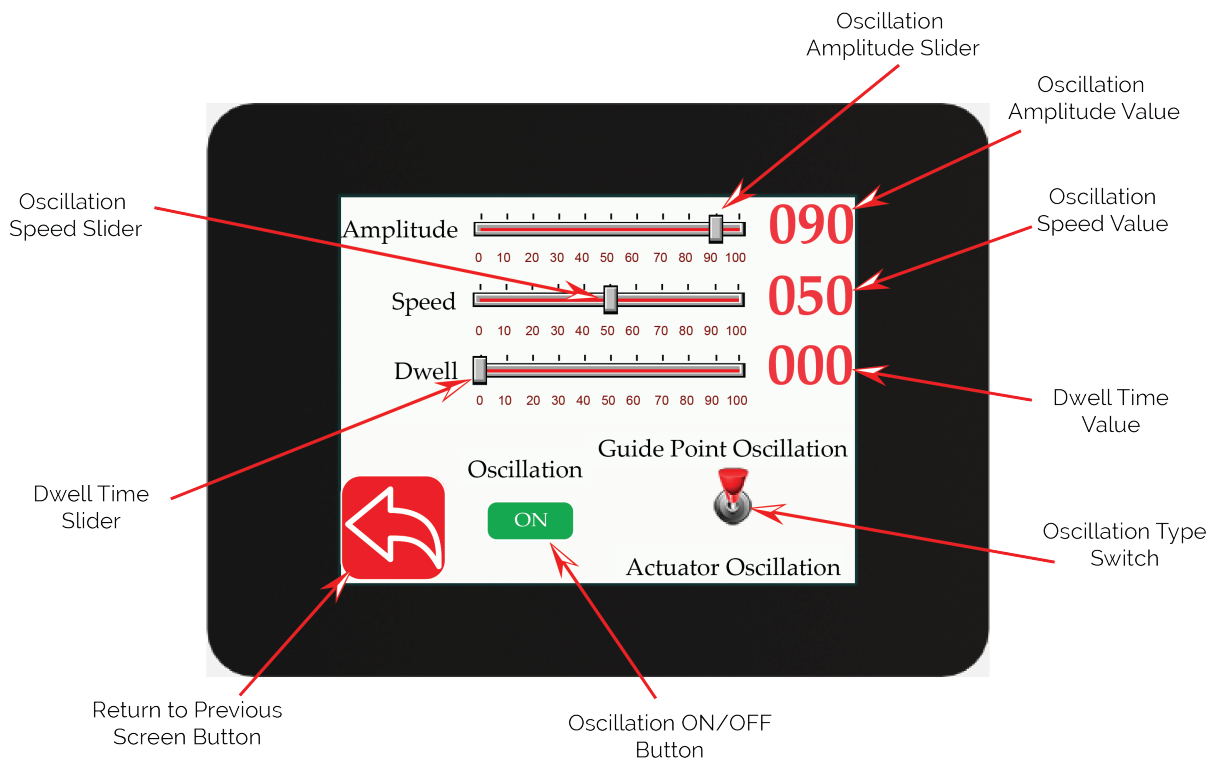


Figure 5.73: Operator Oscillation Screen

5.9.1 Oscillation ON/OFF

The ON/OFF switch for Oscillation is utilized to activate or deactivate this feature. Once the oscillation is activated and depending on the type of oscillation, the web guide oscillation will start immediately when the operator switches the web guide to Auto mode on the operator home screen.

5.9.2 Oscillation Amplitude

The oscillation's magnitude can be adjusted by moving the amplitude slider. This magnitude is consistently expressed as a percentage of the actuator's stroke. For example, if the amplitude is configured to 90% and the actuator's stroke is 100 mm, then the oscillation will be ± 45 mm from the central position. This central position corresponds to the actuator's servo center when the oscillation mode is set to actuator oscillation. Conversely, if the oscillation mode is guide point oscillation, the central position will align with the current guide point of the web guiding system.

Warning

During guide point oscillation, if the amplitude of oscillation is set higher than the sensor(s) range, the amplitude of oscillation will be constrained to the sensor's range, along with the guide point safety factor (± 50 pixels from the edge of the sensor(s) range). When the limits of guide point oscillation reach the guide point safety factor on either side, the dwell period will begin, and the direction will change after the dwell period timeout. Therefore, when conducting guide point oscillation, it is advisable to always set the amplitude to a value lower than the range of the available sensor(s).

5.9.3 Oscillation Speed

The oscillation speed can be adjusted by moving the speed slider. This speed is expressed as a percentage of the current actuator speed.

Warning

Avoid setting the speed to zero as it will completely halt the actuator's movement.

5.9.4 Oscillation Dwell Time

The actuator's dwell time, denoting the duration it stays at each extreme position before reversing direction, needs to be a multiple of 40 ms, with a minimum of 40 ms. For instance, a dwell time setting of 0 corresponds to a 40 ms pause before changing direction, while a setting of 100 results in a 4-second delay before changing direction. It is important to note that the actuator remains stationary during the dwell time at the extreme position.

5.9.5 Oscillation Type

The toggle switch enables the user to alternate between the two types of oscillation.

Actuator Oscillation

Among the functions of the web guide oscillation, actuator oscillation is the most basic one. In this mode, the actuator of the web guide is moved back and forth based on the predefined oscillation speed and magnitude. The servo center position defines the center of the oscillation. Thus, the actuator first moves towards the servo center position before the oscillation begins. No sensor is required for this

mode, and it becomes operational as soon as the user switches the controller to the auto mode on the operator home screen.

 **Note**

The oscillation of the actuator will function whether or not a sensor(s) is connected.

Guide point Oscillation

The guide point oscillation represents a more sophisticated iteration of the web guide oscillation feature. In this system, the web is actively guided, and when the guide point oscillates, the web is steered towards an oscillating position in a closed-loop fashion. In contrast to open-loop actuator oscillation, the web's position remains consistently within the predefined range within the sensor(s) range.

In order for this feature to be operational, it is necessary for one or both sensors to be connected to the controller and at least one sensor is enabled. Once the user switches the controller to automatic mode on the operator's main screen, the guide point track bar and guide point offset will dynamically adjust to reflect the oscillation feature of the guide point. This will make the web guide to follow the guide point.

The center point for the oscillation will be the guide point that was previously accepted, either with fine guide point adjustment (as discussed in Section 5.1.15) or gross guide point adjustment (as discussed in Section 5.1.13) or guide point reset (as discussed in Section 5.1.14).

 **Note**

The guide point oscillation requires a web position sensor to close the loop.

 **Warning**

The oscillation of the guide point will be restricted to the maximum range of the sensor(s), with an additional safety margin, in cases where the magnitude of oscillation exceeds the maximum range of the sensor(s).

5.10 Operator: Flag Detection Screen

The controller also offers flag detection capabilities. In this application, users can configure the controller to detect a flag at the edge of the web. Up to two sensors can be employed for flag detection, and the result can be provided as a digital output. Each sensor will have a dedicated output.

Info

Flag detection is a web sensing system that identifies the existence of a small extension on the web, typically a flag marker measuring approximately 50 mm in the machine direction and 25 mm in the cross machine direction. While the term "flag" is generally used, there are instances where web splicing with tapes may result in a similar protrusion.

In specific scenarios, detecting the presence of a flag while the web is in motion is crucial. By leveraging information such as web speed and the timing of the digital output signal activation, the position of the flag in the machine direction can be monitored within a roll-to-roll machine. This knowledge of the flag's position enables appropriate actions to be taken based on the user's requirements. One typical application involves flag detection before a slitting operation and monitoring the flag's position post-slitting, as the flag may have been removed during the edge trimming at the slit. If a new flag insertion is necessary, it can be accomplished by calculating the distance the flag has traveled in the machine direction using the web speed.

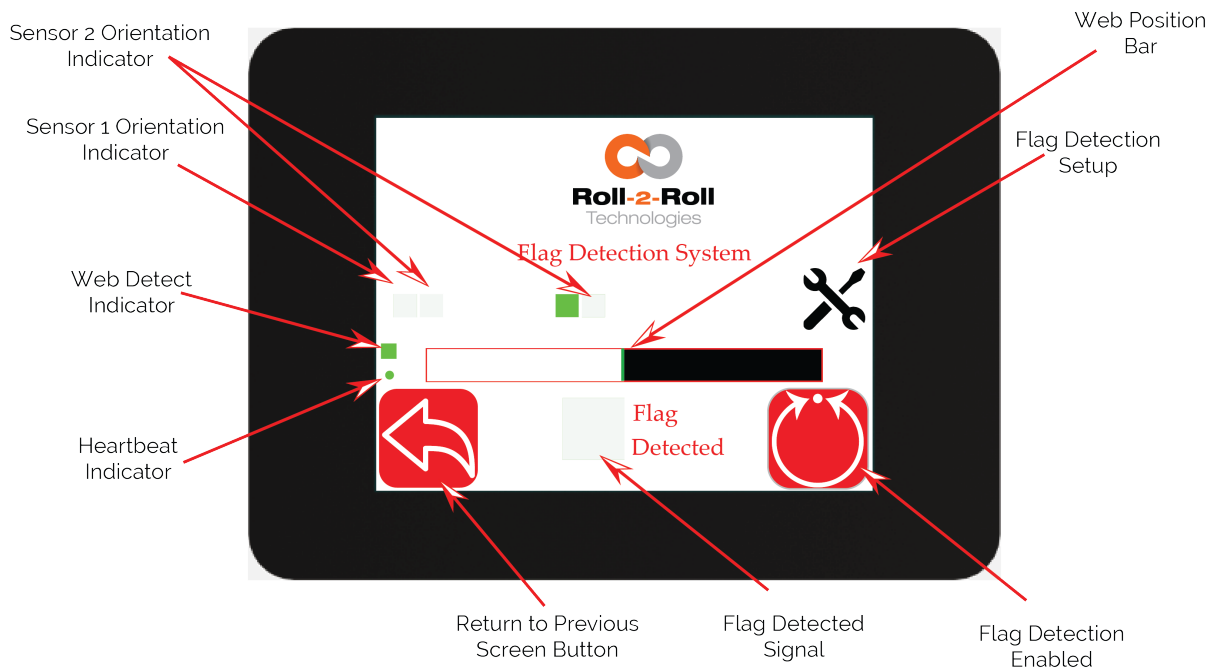


Figure 5.74: Operator Flag Detection Screen

The main screen of the flag detection app resembles the home screen and displays various indicators: web detect, heartbeat, sensor orientation, and a web position bar. These have the same functionality as in the home screen (for more information, see Section 5.1).

5.10.1 Flag Detection Enable/Disable Button

The flag detection feature can be activated by pressing this dedicated button. A green icon indicates that the flag detection algorithm is enabled and will provide valid output, while a red icon signifies that the algorithm is disabled and will not run.

Enabling the flag detection algorithm will restrict the user from moving away from the current screen unless the flag detection is turned off. The navigation icons will vanish once the flag detection is activated, as illustrated in Figure 5.75.

Info

The flag detection algorithm searches for a rapid shift in the web position compared to the current position. Regular movement within the web will not activate the flag signal; only an abrupt change will do so since the algorithm adjusts to the usual web movement.

5.10.2 Flag Detected Signal

There is a visual indicator for the flag detection output that turns green when a flag is detected, providing a clear indication of the status (as shown in Figure 5.76). The visual indicator will remain green for a certain duration of time. This hold time can be set in the flag detection setup screen as discussed in Section 5.11.

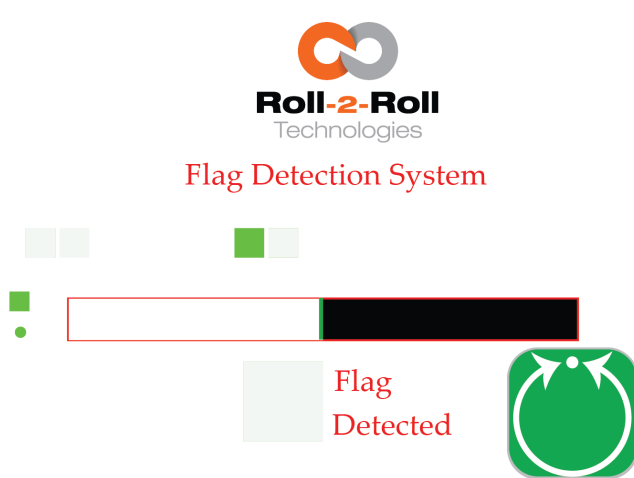


Figure 5.75: Flag detection algorithm enabled

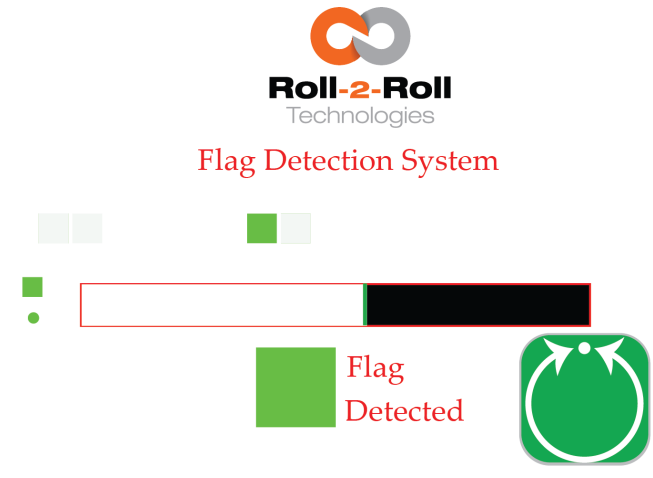


Figure 5.76: Flag detected indication when a flag is detected

5.10.3 Flag Detected Setup

Pressing this flag detection setup button will take the user to the flag detection setup screen (see Section 5.11) where the parameters for the flag detection can be configured.

5.11 Operator: Flag Detection Setup Screen

To function properly, the flag detection algorithm needs certain parameters to be set and this screen allows the operator to set those parameters.

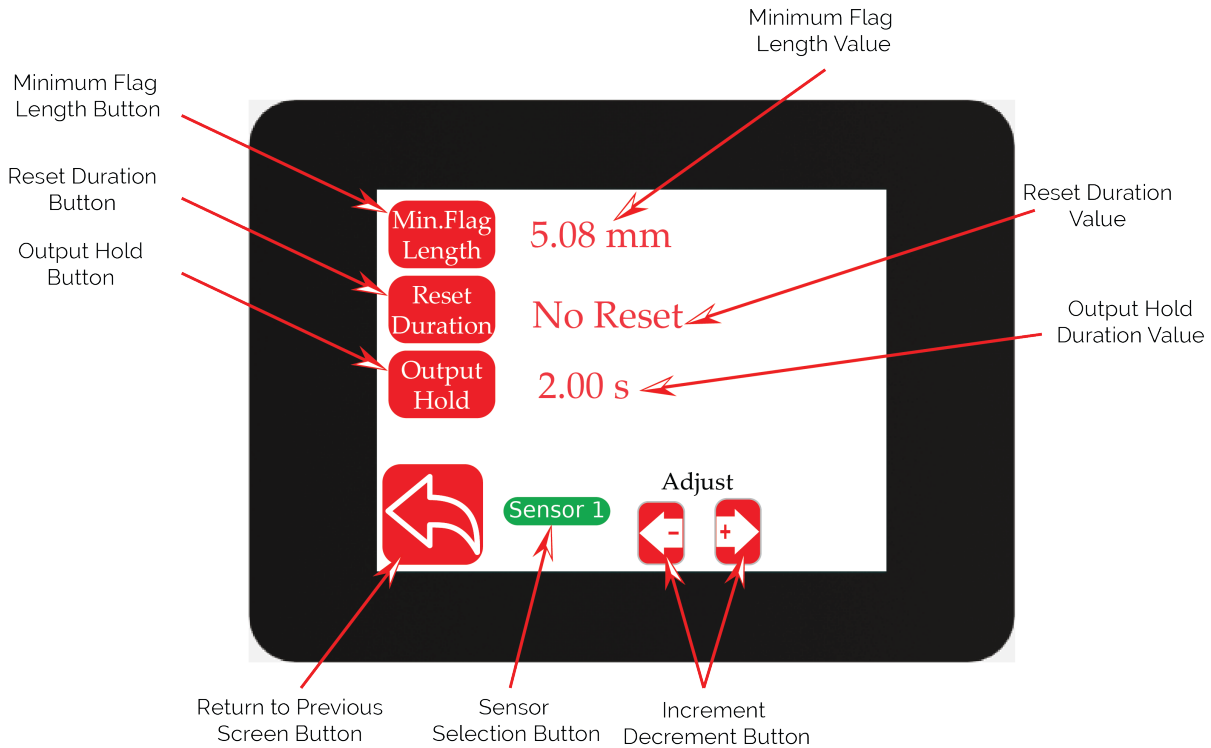


Figure 5.77: Operator Flag Detection Screen

Warning

The algorithm's capacity to precisely identify the flag's location relies on factors such as the flag's length in the machine direction, the web speed in the machine direction, the flag's width in the cross machine direction, and the controller's processing speed. It is recommended to reach out to the factory to verify the suitability of this algorithm for your particular use case.

5.11.1 Minimum Flag Length

When the user selects the minimum flag length button, the increment and decrement keys can be used to change the value of the minimum flag length (as shown in Figure 5.78). This value establishes the minimum length of the flag before triggering a response. This is one of the most important parameters for the flag detection algorithm.

Note

Maximum flag length that can be set is 100 mm and the minimum flag length is 1 mm.

Min.Flag Length 5.02 mm

Reset Duration No Reset

Output Hold 2.00 s

Min.Flag Length 5.02 mm

Reset Duration 0.02 s

Output Hold 2.00 s

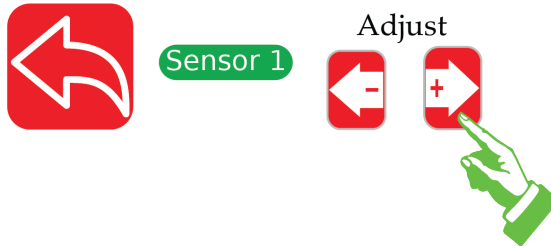
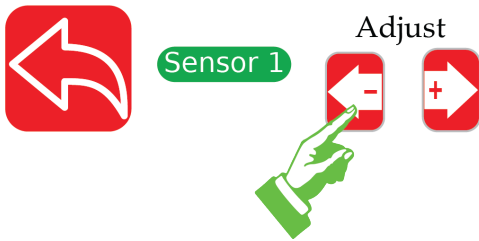


Figure 5.78: Changing the minimum flag length

Figure 5.79: Changing the reset duration

Warning

Setting the minimum flag length too low can create false positives.

5.11.2 Reset Duration

The flag detection algorithm can automatically adjust to web width changes. The reset duration represents the minimum time required before the new web width is regarded as the optimal width to detect flags. If the user prefers not to adjust to web width variations, they can select the "No Reset" option.

Note

The reset duration can range from 0.02 seconds to 5 seconds. Users can specify the value in intervals of 20 ms from 20 ms to 200 ms, then in increments of 100 ms from 100 ms to 1 second, and finally in 1-second intervals from 1 second to 5 seconds. Opting for "No Reset" deactivates the algorithm's automatic reset triggered by changes in web width.

5.11.3 Output Hold Duration

When a flag is detected, the output will be held high for this output hold duration. This value can be changed when this button is highlighted green and by using the increment and decrement button.

i Info

Output holds are necessary while using a PLC with a slow digital input card. This will force the controller to keep the output high after a flag passes the sensor until this duration is met.

📌 Note

The output hold duration can range from 0.02 seconds to 5 seconds. Users can specify the value in intervals of 20 ms from 20 ms to 200 ms, then in increments of 100 ms from 100 ms to 1 second, and finally in 1-second intervals from 1 second to 5 seconds.

5.11.4 Sensor Selection

The flag detection algorithm has distinct parameters for each sensor. Users can adjust the parameters for a specific sensor by switching between sensors using the sensor selection button.

5.12 Power User Menu

The power user menu screen (refer to Figure 5.80) is designed for proficient individuals who are in charge of setting up, diagnosing, and maintaining the Roll-2-Roll® Controllers. It is advised that only qualified personnel have access to these screens. Clicking on any of the icons will navigate the user to the relevant screen. By using the return button, the user can go back to the previous screen within the Advanced Setting Menus.

Important screens within this menu comprise the power user actuator screen, the power user sensor screen, the power user controller screen, the power user analog output screen, the power user password screen, and the power user communication screen. These screens are crucial for the initial setup of the Roll-2-Roll® Controller for a variety of purposes such as sensing, guiding, measuring, and monitoring applications.

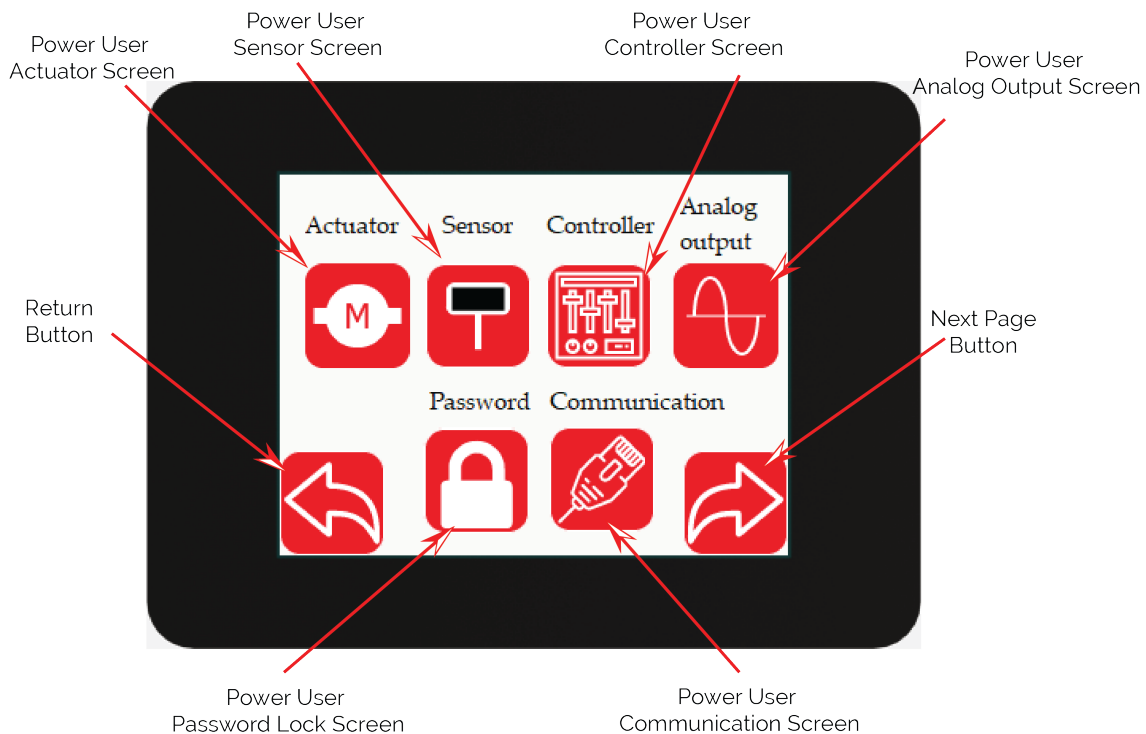


Figure 5.80: Power User Menu Screen

Warning

Modifying these configurations can greatly impact both sensing and guiding functions. Incorrect settings may result in harm to the actuator, web guide, or devices linked to the controller. Therefore, only individuals with a thorough understanding of the web guiding system or the measurement/sensing system should adjust these settings.

5.13 Power User: Actuator Screen

The screen for configuring the actuator enables the advanced user to adjust actuator parameters, such as stroke length, actuator pitch, actuator speed, acceleration, actuator motion polarity and center sensor servo polarity.

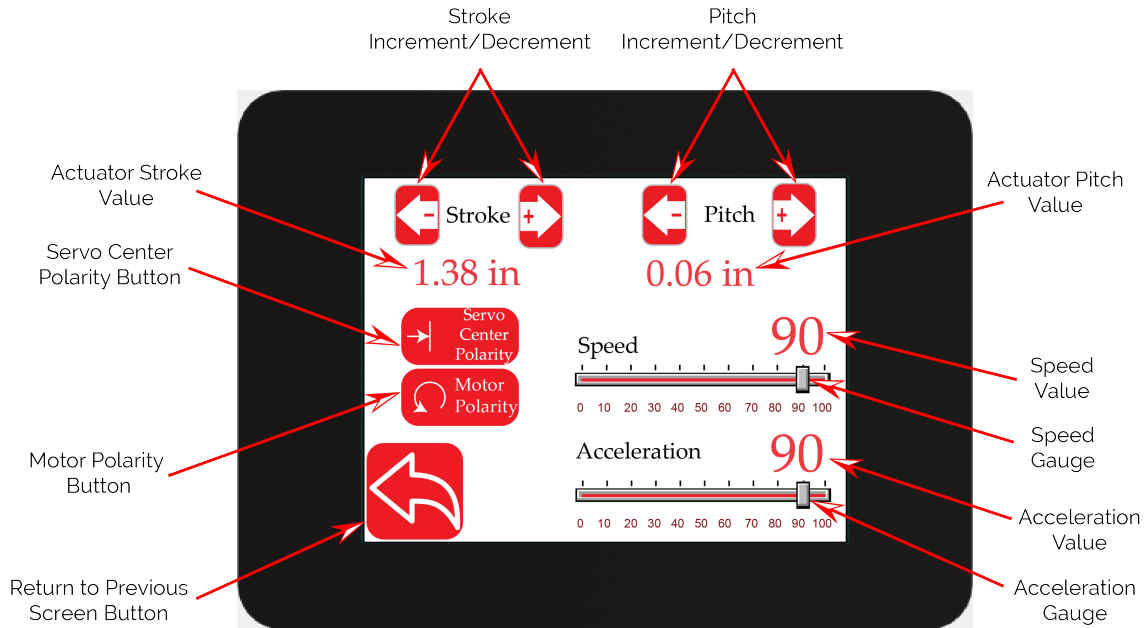


Figure 5.81: Power User Actuator Settings Screen

Warning

The actuator parameters are usually pre-configured by the factory according to the actuator purchased, and any adjustments should be made in consultation with the factory. Apart from adjustments to speed and acceleration, other parameters should remain unchanged following the initial configuration and commissioning of the web guiding system.

Note

The actuator settings are meant to be adjusted by maintenance staff who possess adequate understanding of the web guiding system and its operation. Typically, these configurations are modified during the system's initial setup, following an actuator upgrade or replacement, or after a retrofit installation.

5.13.1 Actuator Stroke (Digital)

The digital stroke length of the actuator can be changed in multiples of 5 mm (0.2 in) and can be incremented or decremented using the stroke increment/decrement keys. This digital stroke setting is used to keep track of the distance the actuator can move on either side from the servo center position. Hence from the middle position (servo centered position) the actuator will travel half the stroke length

on either side. This digital stroke length setting helps prevent the actuator from hitting any mechanical limits and prevents any motor damage in the event that the actuator moves when no web is present.

Info

- *The software digitally monitors the position of the actuator, and the actuator ceases operation when the digital boundaries are reached. This tracking is facilitated by the step count from the stepper motor driver without the need for external encoders. Therefore, position monitoring occurs exclusively when both the Roll-2-Roll® Controller and Roll-2-Roll® Driver are powered ON.*
- *The digital range limit of the actuator may not align with the physical boundaries of either the actuator or the web guide structure. Ideally, these limits should always be set lower than the physical stroke limit of the web guide structure. These digital boundaries serve to prevent the actuator from reaching its mechanical limits and to avert any potential motor overheating issues.*

Warning

- *Avoid configuring the digital stroke length to exceed the physical stroke length of the actuator. Doing so could result in damage to the actuator.*
- *To avoid potential harm to the actuator, ensure that the digital stroke length is not configured to exceed the physical stroke length of the web guide structure. The stroke capacity of the web guide structure may be lower than the physical stroke of the actuator. Therefore, it is advisable to always set the digital stroke to the lesser of the actuator stroke and the stroke capacity of the web guide structure.*
- *If the servo center position is not precisely at the midpoint of the mechanical limits of the web guide, adjust the digital stroke length to ensure that the actuator motion does not reach the mechanical limits on either extreme position.*

5.13.2 Actuator Pitch (Digital)

The pitch of the actuator refers to the displacement of the actuator for each revolution of the motor. While technically it is known as the lead of the actuator, in the terminology of our controller, these terms are used interchangeably.

The actuator's digital pitch can be adjusted in increments of 0.25 mm (0.01 in) using the pitch increment/decrement keys. This adjustment is crucial as it determines the number of rotations required for the motor to reach its stroke limit, which is calculated according to the pitch configuration. If the configured value does not align with the actual pitch of the actuator, the actuator may move more or less depending on the direction of the discrepancy.

Warning

- *Modifying the pitch setting could affect the digital position count of the actuator, consequently affecting the actuator's effective stroke. Increasing the pitch beyond its current value would shorten the effective stroke, while decreasing it would extend it.*
- *Avoid setting the pitch lower than its current value to prevent the actuator from reaching its mechanical limits and potentially causing damage.*

5.13.3 Motor Polarity

The motor polarity setting is used to invert the actuator's direction. Pressing the motor polarity button switches between rotating counter-clockwise (Red button) and clockwise (Green button).

This configuration alters how the actuator functions in both automatic and manual modes. Depending on how the actuator is installed, its polarity can be adjusted to ensure that the jog left and jog right buttons correspond to the operators' desired direction of motion for the web guide.

Info

It is common practice to initially establish the motor polarity according to the operator's preference. Subsequently, if this causes the web guide to move in the opposite direction while in automatic mode, the polarity of the controller in automatic mode can be adjusted. The controller error polarity for automatic control can be edited in the Power User Controller Screen, as illustrated in Section 5.15.3.

Warning

Following the commissioning of the web guide, altering the polarity of the motor will lead to a malfunction of the web guide. Therefore, this should only be considered if there are modifications to the installation conditions. Adjustments to the motor polarity setting should be performed exclusively by experienced users.

5.13.4 Servo Center Polarity

The polarity of the servo center sensor can also be changed to accommodate various locations for the servo center sensor installation. This may be necessary if the location of the servo center is changed or if a different type of servo center sensor is used. Pressing the servo center polarity button will switch between the two polarities.

Info

Usually, an M12 24 VDC NPN inductive proximity sensor paired with an appropriate metal target is employed for identifying the servo center point. This point can be identified either on the web guide framework or directly on the actuator. It is important to highlight that due to variations in the web guide structure and its setup, the midpoint of the actuator's stroke may not consistently align with the central position of the web guide structure. Nevertheless, it is crucial to clarify that the servo center point refers to the central position of the web guide structure rather than that of the actuator. The servo center sensor is positioned to sense a target during one-half of the actuator stroke, while it does not sense the target during the other half of the stroke. The point where this transition occurs will serve as the servo center position or the home position for the web guide mechanism. When the servo center button is pressed on the web guide controller, the initial state of the sensor is recorded before moving the actuator in a direction towards the servo center position. The direction in which the actuator moves depends on the polarity setting of the servo center functionality.

Note

When employing sensorless software-based servo center functionality, the polarity of the servo center has no impact on the process of servo centering.

Warning

- If the servo center polarity is set incorrectly, the actuator would move away from the center position. This might cause a controller fault and the controller will automatically disable the sensor-based servo center functionality and will revert to sensorless software-based servo center functionality.
- If the distance between the target and the proximity sensor goes beyond the working distance of the proximity sensor the functionality of the sensor based servo center operation would fail and cause the same fault as above. Standard working distance for inductive proximity sensors is around 1.5 mm to 3 mm.
- Following the commissioning of the web guide, altering the polarity of the servo center sensor will lead to a malfunction of the web guide. Therefore, this should only be considered if there are modifications to the installation conditions. Adjustments to the servo center sensor polarity setting should be performed exclusively by experienced users.

5.13.5 Actuator Speed

Info

The Roll-2-Roll® Controller in conjunction with the Roll-2-Roll® Driver employs a distinct control mechanism for web guiding. In contrast to conventional control systems, the control loop of the Roll-2-Roll® Controller does not rely on velocity-based control but rather on position-based control. By evaluating the error in web position (guidepoint - actual web position), the Roll-2-Roll® Controller issues a position command indicating the necessary actuator movement. Consequently, each adjustment or correction in automatic mode follows a trapezoidal motion profile, featuring consistent acceleration until reaching maximum speed, maintaining this speed just before the target position, and then decelerating steadily until coming to a stop. At each sampling interval, a new position command is transmitted to the driver, which consistently adheres to the trapezoidal motion profile to achieve the desired position. Depending on the magnitude of the position command, the motion profile may take the form of either a trapezoid or a triangle (comprising only acceleration and deceleration phases). The position commands automatically update the motion profile in real-time. This type of control system offers enhanced stability and reliability in comparison to velocity-based control systems.

The highest achievable speed for the trapezoidal profile can be adjusted by modifying the actuator speed slider. By default, this slider adjusts the speed relative to the maximum permissible speed of the selected actuator as a percentage.

Note

The maximum permissible speed of the chosen actuator is established by Roll-2-Roll Technologies and is preconfigured. This velocity is influenced by the motor properties and the lead/pitch values of the actuator. It is adjusted to ensure that the stepper motor does not miss steps provided that the actuator is appropriately sized for the thrust needed.

 **Warning**

If the speed is set to zero, the actuator will remain stationary in both manual and automatic modes.

5.13.6 Actuator Acceleration

The actuator acceleration can be increased or decreased using the slider. The set of values indicates the percentage of the maximum and minimum acceleration settings for the actuator. Higher acceleration may result in lower thrust output from the actuator.

 **Warning**

If the acceleration is set to zero, the actuator will remain stationary in both manual and automatic modes.

5.14 Power User: Sensor Screen

The screen allows for the configuration of advanced sensor parameters. Experienced users have the ability to activate or deactivate a specific sensor, force the orientation of a sensor, and select the sensor type.

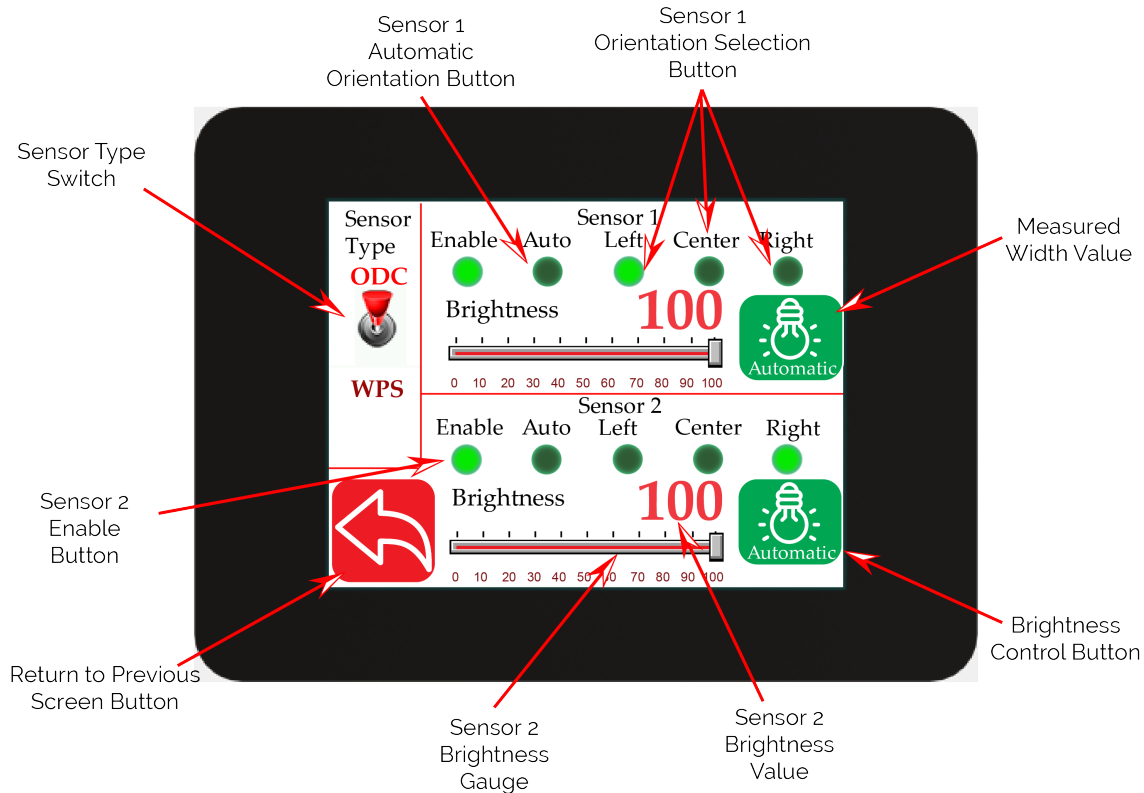


Figure 5.82: Power User Sensor Settings Screen

5.14.1 Enable/Disable Sensor Button

This button provides the power user with the capability to electronically activate or deactivate a sensor. When the button is pressed, it will either enable or disable the sensor accordingly. If the sensor is enabled, the button will appear in lime green color (as depicted in Figure 5.82), whereas if it is disabled, the button will be dark green. By default both sensors are enabled as part of the default factory settings.

In some cases, it might be essential to deactivate a sensor linked to the controller. For instance, in a scenario where two sensors are monitoring two different positions to regulate a single web guide structure or actuator, only one sensor is utilized for feedback control at any given time. Another scenario arises when two sensors are positioned at different locations cross-machine location to perform distinct tasks on webs of varying widths. In such situations, operators can utilize the Find Edge button (refer to Section 5.1.7) to easily alternate between the two sensors directly from the homescreen depending on the specific job being run.

Info

When two sensors are connected to the controller and enabled, the web position measurements from both sensors are used to compute the centerline position of the web material which is then used to compute the error for the automatic web guiding operation. With the exception of the controller being in Master/Slave mode where the functionality of the two sensors are as per the discussion in Section 5.16.

The enable/disable sensor button allows users to physically connect two sensors to the controller while utilizing only one sensor for web guiding operations. This feature enables rapid switching between products without the necessity of physically connecting or disconnecting the unused sensor. Disabling a sensor electronically will have the same effect as unplugging the sensor physically.

Note

It is recommended to keep the sensors enabled with the factory default setting unless there is a specific need to disable them, in order to prevent any potential confusion.

5.14.2 Sensor Orientation Buttons

In edge detection mode, the controller scans the image for a first valid edge from left to right or from right to left, depending on the chosen sensor orientation. During a left-to-right scan, the process initiates at the zeroth pixel and moves towards the Nth pixel on the sensor to detect the leftmost valid edge. Conversely, in a right-to-left scan, the controller identifies the rightmost valid edge by starting at the Nth pixel and moving towards the zeroth pixel. A valid edge is characterized as the boundary between the area without a web (or background where no light is reflected back to the sensor) and the position of the web's edge.

For example, in Figure 5.83, it is recommended to set the sensor on the left to a left orientation to detect the left edge of the web, and similarly, the right sensor should be set to a right orientation to detect the right edge of the web. In the case of the 48 mm sensor shown, the pixel indexed as zero is located on the far left when looking directly at the sensor, as illustrated in Figure 5.83. Correspondingly, the Nth pixel is located on the right-hand side when observing the sensor from the front. Additionally, the ODC 48 sensor includes a label on the faceplate that indicates the correct orientation.

In the case of WPS 112 to WPS 900 and ODC 96 to ODC 960, the zeroth pixel is located on the sensor side without the connector, while the Nth pixel is located on the side with the connector. Figure 5.84 illustrates a sample setup featuring two ODC 96 sensors. It is advisable to configure the left sensor in a left orientation to capture the left edge and the right sensor in a right orientation to capture the right edge.

Note

When employing two sensors, it is essential to ensure that both sensors are positioned in the same direction, with their connectors facing the same direction with respect to the web, as illustrated in Figures 5.83 and 5.84. This guarantees that the one-dimensional image produced by scanning from the first pixel to the last pixel is consistent in direction across both sensors.

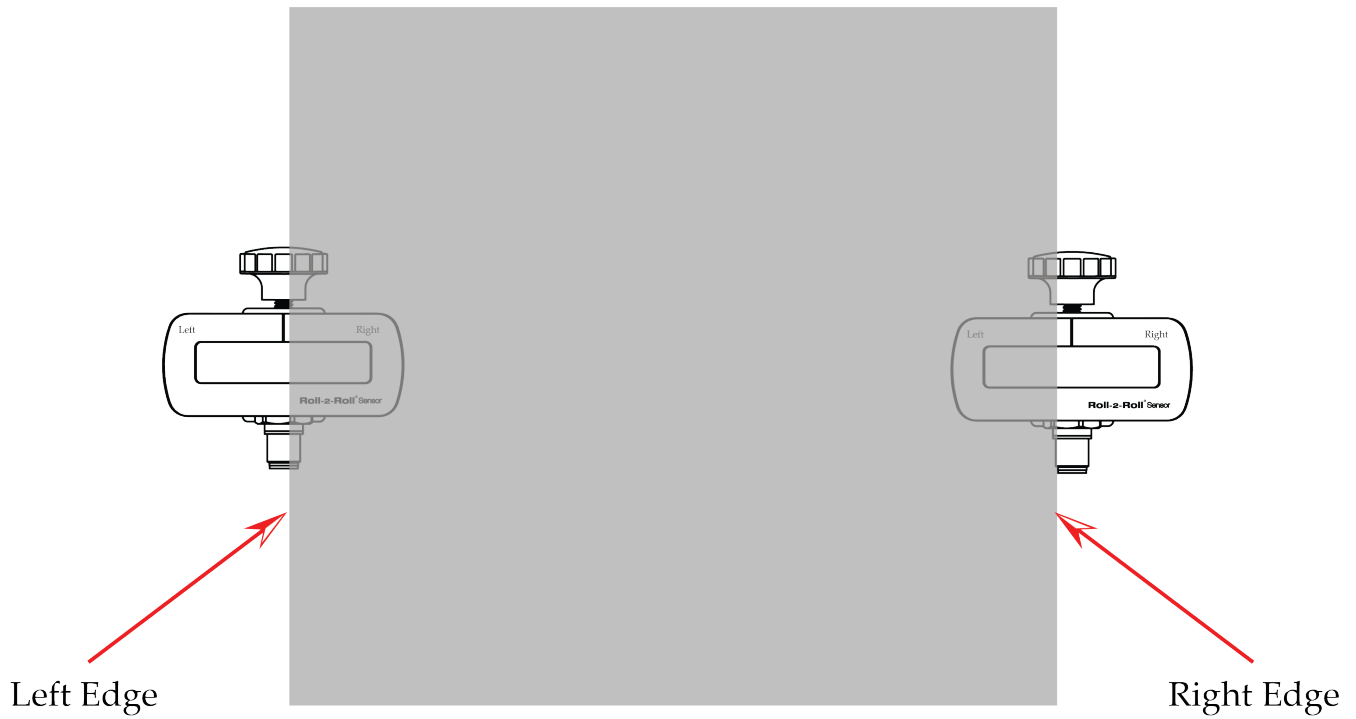


Figure 5.83: Proper sensor orientation for ODC 48 and WPS 48

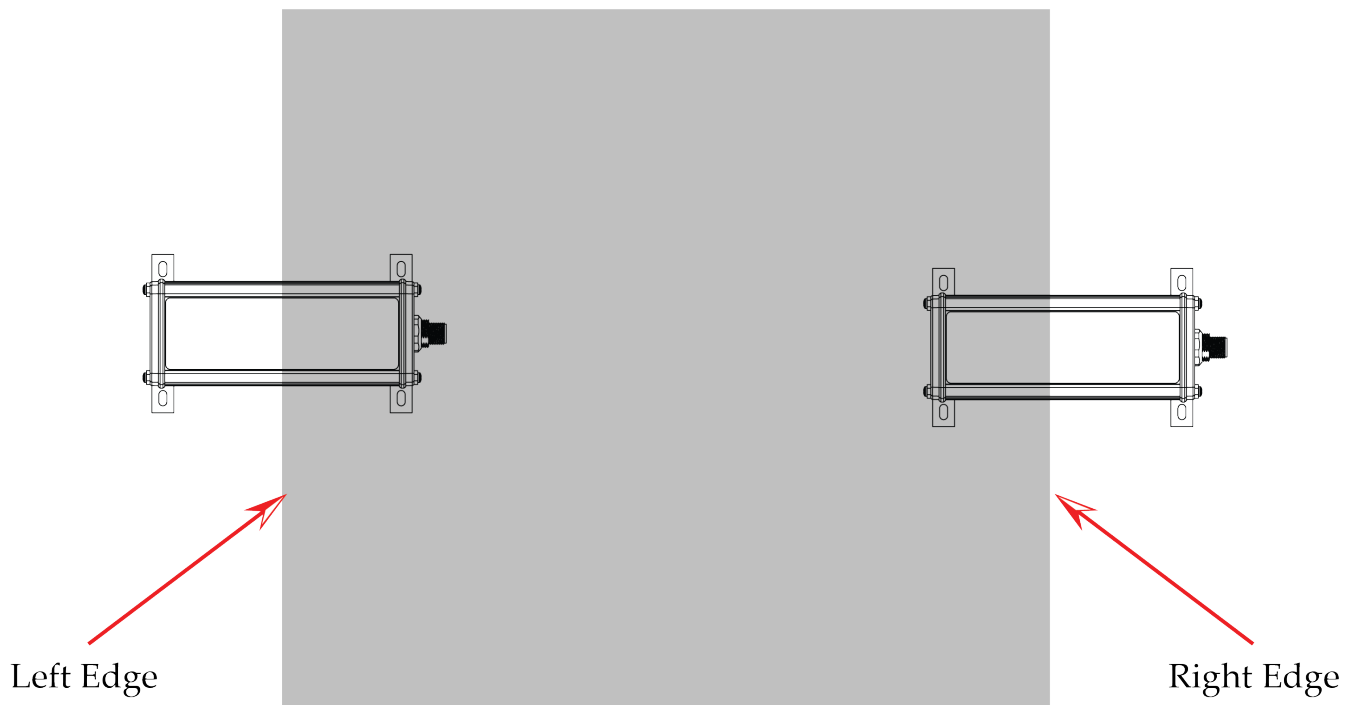


Figure 5.84: Proper sensor orientation for ODC 96 - ODC 960 and WPS 112 - WPS 900

Warning

If the scanning directions of the two sensors are opposite and one sensor is mounted upside down in relation to the other sensor, the functionalities of web guiding and web width measurement applications would be compromised. This will actually cause the web guide to malfunction and incorrectly indicate the web width.

Automation Sensor Orientation Button

The user can enable automatic detection of sensor orientation (as described in Section 5.1.7) by pressing the auto button. The button will change to a lime green color to signal that the mode is activated. Once the automatic sensor orientation is turned on, all other sensor orientation modes will be automatically deactivated. Enabling this mode will cause the sensor orientation to be automatically detected in relation to the web displayed in the sensor's field of view when the find edge button on the home screen is pressed. This function proves beneficial in situations where the sensors are positioned far away, making it challenging to determine the correct orientation based solely on the sensor placement. In such instances, the controller will autonomously identify the orientation by observing how the web is presented to the sensor.

Note

It is advisable to utilize the automatic sensor orientation feature solely during the initial setup to expedite the commissioning process. Once the accurate sensor orientation is automatically identified, it is recommended to manually set the sensor state to either left, right, or center as outlined in the subsequent sections.

Force Left Sensor Orientation Button

Pressing the left button will force the sensor orientation to left orientation. The button will change to a lime green color to signal that the mode is activated. Once the left sensor orientation is turned on, all other sensor orientation modes will be automatically deactivated.

Info

Sensor orientation also works the same way in contrast mode. The controller will look for the taught contrast while scanning from left to right when the sensor is set to left sensor orientation.

Force Center Sensor Orientation Button

Pressing the center button will force the sensor orientation to center orientation. The button will change to a lime green color to signal that the mode is activated. Once the center sensor orientation is turned on, all other sensor orientation modes will be automatically deactivated.

In the center orientation mode, the controller will simultaneously monitor the leftmost and rightmost edges. This configuration is employed when the width of the web is less than the sensor's field of view, allowing a single sensor to capture both edges of the web. Center guiding and width measurement are common applications for using the center mode.

Info

The sensor cannot be configured to the center orientation when the sensor mode is set to contrast.

Force Right Sensor Orientation Button

Pressing the right button will force the sensor orientation to right orientation. The button will change to a lime green color to signal that the mode is activated. Once the right sensor orientation is turned on, all other sensor orientation modes will be automatically deactivated.

Info

Sensor orientation also works the same way in contrast mode. The controller will look for the taught contrast while scanning from right to left when the sensor is set to right sensor orientation.

5.14.3 Sensor Type Selection Button

The controller is compatible with two varieties of Roll-2-Roll® Sensors: WPS and ODC. The WPS is an outdated sensor model that will no longer be supported after 2025. On the other hand, the ODC is the most recent sensor model equipped with CMOS line scan cameras. The controller can only operate with one sensor type at a time. Users can switch between sensor types by toggling the switch designated for this purpose.

Note

In order to avoid unintended modifications, the user needs to confirm the change by selecting the accept button that is displayed when switching the sensor type.

5.14.4 Brightness Gauge

As described in Section 5.5.5, the brightness gauge and the numerical value displayed alongside indicate the percentage of LED brightness emitted by the corresponding sensor. In freeze mode, the gauge can be utilized to manually adjust the brightness level, ranging from 0% to 100%. In automatic mode, the indicator reflects the current brightness level. Modifying the brightness setting during automatic mode will reset the automatic brightness control algorithm and display the live updates of brightness on the indicator and numerical display.

5.14.5 Brightness Control

As described in Section 5.5.6, the controller is equipped with an automated brightness control algorithm that adjusts the brightness of the sensor's LEDs according to the captured image. This algorithm is designed to optimize image quality based on specific criteria and assist in background suppression. Users have the option to deactivate the automated brightness control to manually adjust the LED brightness. By pressing the brightness control button, users can switch between automatic mode and manual control.

When the manual mode is activated, the icon will change its color to red and display "Freeze." Conversely, if the automatic brightness control is switched on, the icon will turn green and show "automatic."

i Info

The brightness control and brightness gauge are available for control on both the operator sensor screen (Section 5.5) and the power user sensor screen.

5.15 Power User: Controller Screen

This interface enables the user to configure the controller parameters specific to the web guiding application with Roll-2-Roll[®] Driver and Roll-2-Roll[®] Actuator.

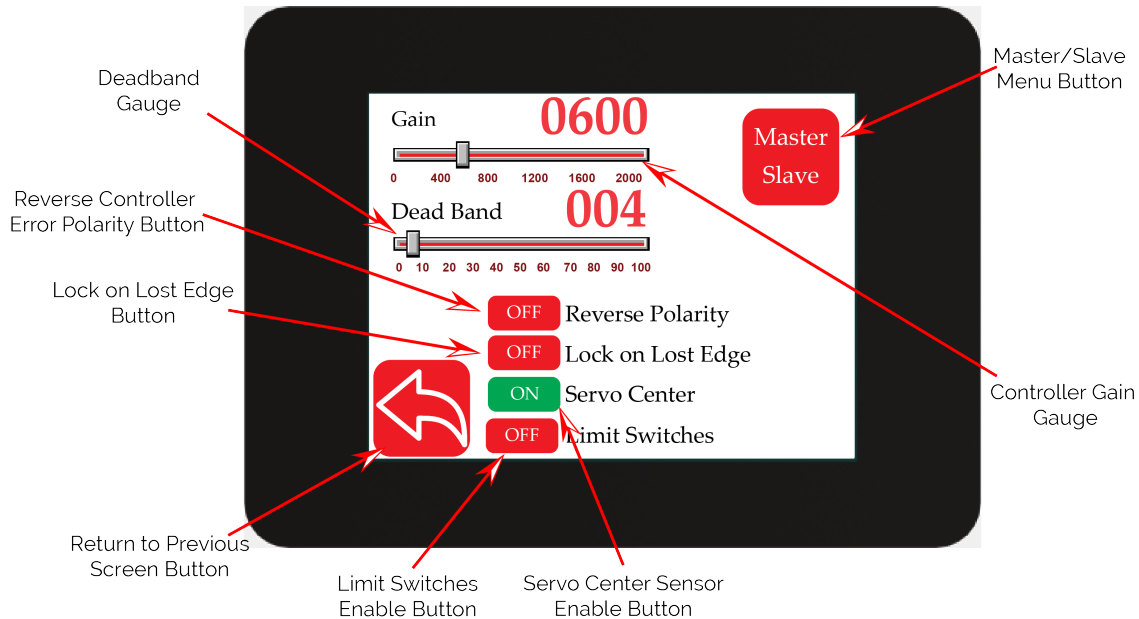


Figure 5.85: Power User Controller Screen

Info

Unlike conventional systems where the actuator speed is adjusted in accordance with the web position error's size, the Roll-2-Roll[®] Controller ensures a consistent response regardless of the error magnitude. In typical control setups, a minor error leads to a slow actuator velocity, resulting in a sluggish reaction to minor error variations. In some cases, when the velocity is extremely low, it may not be sufficient to overcome the static friction of the web guide mechanism, resulting in the inability to correct a minor error. Conversely, with the Roll-2-Roll[®] Controller, the actuator's speed and acceleration for correction remain unaffected by the error magnitude, guaranteeing a prompt response to even minor errors.

The operational approach for the Roll-2-Roll[®] Controller is outlined as follows:

- The error for the web guide controller is determined by subtracting the web position detected by the Roll-2-Roll[®] Sensor(s) from the guide point offset.
- Both the instantaneous error and the rate of change of error are employed to determine the required position correction based on the gain configuration.
- This position correction serves as a position command to the Roll-2-Roll[®] Driver, enabling the actuator to move to the new position following the predetermined speed and acceleration motion profile.
- A new position command is provided to the Roll-2-Roll[®] Driver every 20 ms based on the computed error from the Roll-2-Roll[®] Controller.

5.15.1 Controller Gain Gauge

The gain adjustment is necessary and should be tailored to the actuator lead screw and the mechanical advantage of the web guide structure. This parameter dictates the distance the actuator travels in response to the error magnitude. In contrast to traditional controllers, the Roll-2-Roll® Controller employs a sophisticated non-linear position-based controller with separate configurations for position gain, velocity, and acceleration of the actuator. The optimal gain setting for the actuator or web guiding system is based on factors such as the pitch of the lead screw, the microsteps of the driver and the mechanical advantage of the web guide structure. Typically, the controller comes preconfigured with the recommended gain values from the factory.

Note

If the gain is set to zero then the actuator will not respond to any error when in automatic mode.

Warning

This parameter has the potential to influence the stability of the entire web guiding system and should therefore be adjusted cautiously. If the gain is set too high, it may result in the web guide oscillating in both directions.

5.15.2 Deadband Gauge

Deadband refers to the region surrounding the guide point within which the actuator remains inactive in automatic mode if the web is located in that region. This numerical value is specified in pixels, with a default deadband size of 4 pixels or 0.25 mm. In this configuration, the actuator will stay stationary in automatic mode if the web is positioned within ± 4 pixels or ± 0.25 mm around the guide point. If the deadband is set to zero, the actuator will be activated whenever there is any deviation from the desired position.

Note

- Broader deadbands are suitable for webs with uneven or irregular edges.
- Setting the deadband to zero will result in constant actuator movement, which is not recommended; unless when requiring tighter web guiding position tolerance.

5.15.3 Reverse Error Polarity

The error polarity of the web guide controller may need to be adjusted based on how the sensor and actuator are set up, to guarantee that the web guide moves appropriately in automatic mode. Activating the reverse polarity button can switch the error polarity of the web guiding system.

Warning

If the polarity is incorrectly configured, the web guide will quickly move to an extreme position in response to even minor deviations in the web position once the controller is in automatic web guiding mode.

5.15.4 Lock on Lost Edge Button

In certain scenarios, it might be essential to inhibit the actuator's movement in automatic mode if the sensor does not detect a web edge within its field of vision. Enabling this parameter will cause the actuator to halt its movement when the sensor fails to detect a web. This functionality resembles the automatic interlock mode found in the contrast guiding application.

Note

- *This configuration is specifically designed for edge guiding applications as it is already implemented by the interlock feature in contrast guiding.*
- *This configuration is specifically designed for single edge guiding using one sensor.*
- *The actuator will be in motion when the sensor window is entirely covered by the web. It will come to a halt only when the sensor no longer detects any web.*
- *If two sensors are in use, both sensors must detect the absence of the web for this function to operate.*

5.15.5 Servo Center Sensor Enable Button

The servo center feature is commonly established using an inductive proximity sensor that detects the servo center/home position, as detailed in Section 5.13.4. It is feasible to deactivate the servo center sensor and rely solely on sensorless software-based motor position readings. This setting allows for the activation or deactivation of an external proximity sensor for servo centering. It is advisable to utilize an external servo center sensor whenever possible.

Note

If the servo center switch is deactivated, pushing the servo center button will move the actuator to the digital home/middle location. However, it should be noted that this position may not correspond to the actual home/middle position of the actuator.

Warning

- *Enabling an external servo center sensor without having one installed will cause the actuator to continue moving until it reaches its physical limit. This could lead to the actuator hitting its mechanical limit and potentially damaging it. Nonetheless, the controller will detect the absence of the servo center sensor and initiate an alternative procedure to return the actuator to its mid-stroke position. The duration of this process will vary depending on the actuator's stroke and speed settings. If the servo center sensor is not detected by the controller, it will automatically revert the servo center sensor setting to OFF.*
- *If the servo center polarity is incorrectly configured, the controller will execute the aforementioned procedure. Therefore, in such a scenario, the servo center polarity must be reversed before reactivating the servo center switch. See Section 5.13.4 for more information about servo center polarity setting.*
- *If the inductive proximity sensor is positioned too far from the target to trigger the switch, the servo center routine may fail to locate the home or middle position. This behavior will be similar to the scenario when no servo center sensor is present.*

5.15.6 Limit Switches Enable Button

For high dynamic response or high load applications, where the controller is pushed to get the best possible speed and acceleration performance, it may be necessary to install physical limit switches since the digital position count from the controller may not be accurate. In those cases, the limit switch can be turned ON.

Alternatively, for safety applications, these limit switches can be used to stop the actuator from moving when a guard door is open.

Note

- *Turning off the limit switch will only deactivate the physical limit switch. The electronic limit, which relies on the actuator stroke, will remain active to halt the actuator's movement when the position count is electronically reached.*
- *When the limit switches are employed for safety purposes, both the left and right limit switches need to be linked to a unified actuator inhibit signal.*
- *Enabling the limit switch but having the physical switches improperly installed will prevent the actuator from moving altogether. This will also disable the Jog and Servo Center functions.*

5.16 Power User: Master Slave Setup Screen

This interface allows the user to set up a Master/Slave or Chase/Follow system by connecting one sensor for the master web and one sensor for the slave web to the Roll-2-Roll[®] Controller.

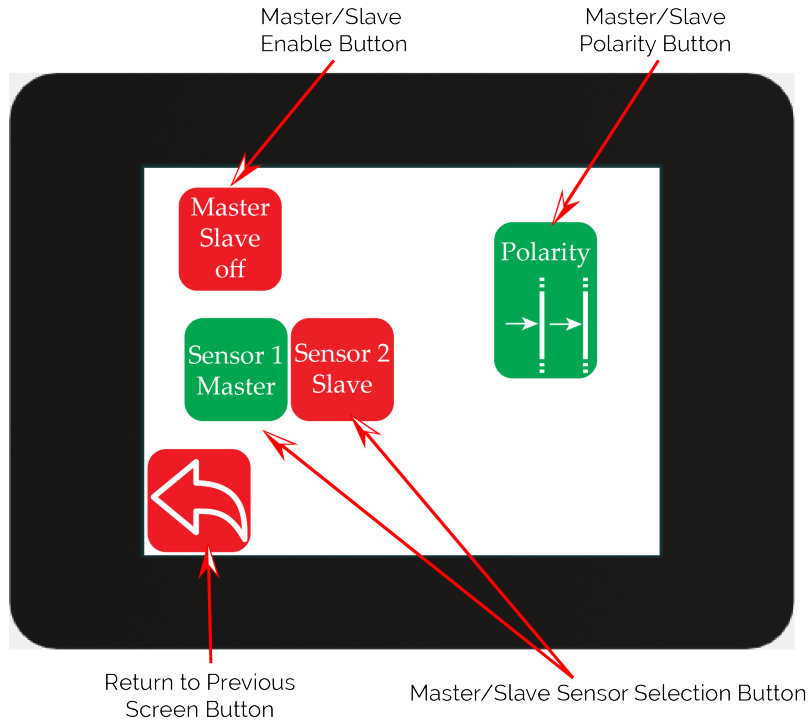


Figure 5.86: Power User Master/Slave Screen

i Info

Master/slave guiding is a method employed to align two layers of web material, with one layer positioned over the other. This procedure includes measuring the location of the unguided master web, which acts as the base substrate. The position data is then transmitted to a slave web guiding system. The slave web guide uses this data, referred to as the guidepoint offset, to precisely steer the web material. As the master web shifts, the guide point of the slave web is modified correspondingly, guaranteeing that the slave web is directed to a position that upholds the correct lamination between the two webs.

Proper sensor placement is crucial for both the master and slave components. It is essential that the distance in the machine direction between the slave sensor and the lamination point matches the distance between the master sensor and the lamination point, as illustrated in Figure 5.87. This alignment is necessary to ensure that the correction signal at the slave sensor reaches the lamination point simultaneously with the deviation recorded at the master sensor position.

Ideally, both the master sensor and the slave sensor should be positioned at the same location along the cross-machine direction of the machine. Otherwise, an adjustment in the guide point offset would be necessary to avoid any discrepancy in steady-state error.

Ideally, both sensors should be directed towards the same side edge of the material. It is permissible to position the sensor on the opposite edge as long as the width of the web remains constant. Placing the sensors on the opposite edge is feasible only if the master/slave polarity can be adjusted in the controller.

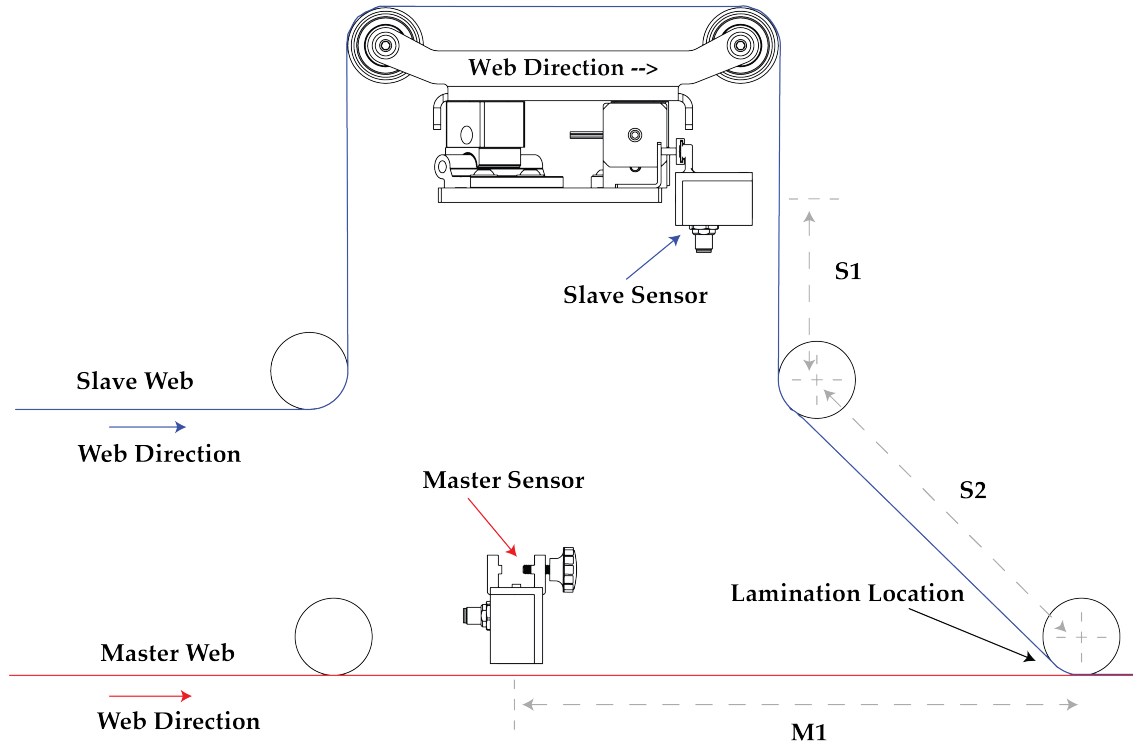


Figure 5.87: Master/Slave Sensor Installation Recommendation

5.16.1 Master/Slave Enable Button

Pressing the enable button for the master/slave will change the status of the master/slave feature. When the button is red, the feature is deactivated, whereas when it is green, the feature is activated.

Note

- Enabling the master/slave mode causes the guidepoint bar on the main operator interface screen to be adjusted according to the feedback from the master sensor.
- The guide point reset feature will reset the guidepoint using input from both the master and slave sensors.
- In master/slave mode, the web position indicator on the main operator interface screen displays only the web position of the slave sensor responsible for guiding.

 **Warning**

If one or both sensors are disabled while in Master/Slave mode, the web guide will not move while in automatic mode.

5.16.2 Master/Slave Sensor Selection Button

The master-slave feature involves connecting and enabling two sensors with the controller. One sensor must act as the master while the other acts as the slave. This button enables the user to switch between selecting the master and slave sensors.

 **Warning**

The web guide must utilize the slave sensor, not the master sensor. Selecting the master sensor for the web guide can lead to the guide moving to its maximum limits or behaving unpredictably.

5.16.3 Master/Slave Polarity Button

The adjustment of the lamination polarity of the master in relation to the slave may be necessary depending on how the sensors are installed for both devices. The Maser/Slave polarity button allows the user to change between the polarity to ensure that the webs are aligned at the lamination point.

5.17 Power User: Analog Output Screen

On this screen, users establish the analog output parameters for the Roll-2-Roll® Controllers equipped with analog output capability (see Section 4.1 for more information). When a specific parameter is chosen, the button will change to lime green to show it is the active selection, while it will appear dark green to indicate an inactive selection. Each controller has only one analog output mode. Although both voltage and current are accessible simultaneously (via separate wires as described in Section 4.4.5), they both relate to the same selected analog output mode.

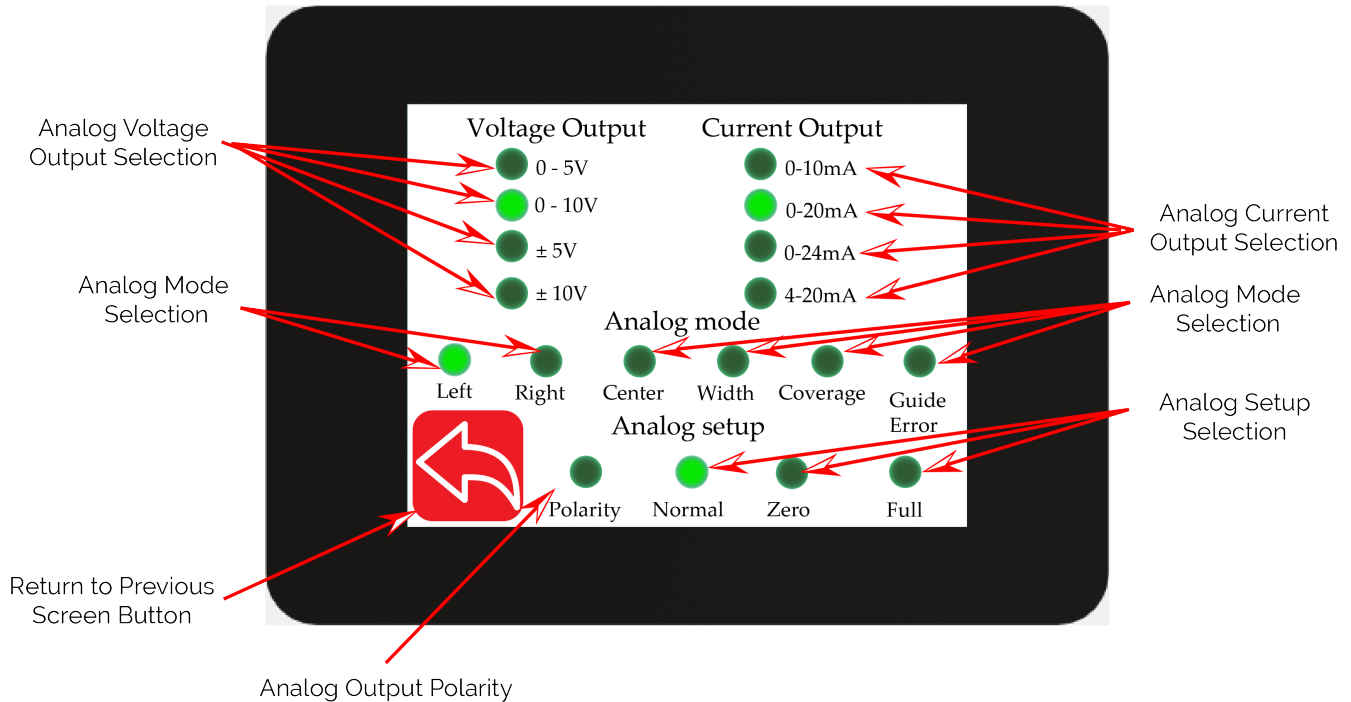


Figure 5.88: Power User Analog Output Screen

Info

The 12-bit digital-to-analog converter (DAC) within the Roll-2-Roll® Controller provides 4095 unique voltage or current levels from zero to full-scale. Therefore, when the sensor range exceeds 4096 pixels, the analog output resolution is lower than the measurement resolution of the Roll-2-Roll® Sensor. Moreover, activating sub-pixel approximation results in a coarse analog output when utilizing more than 1024 pixels from the Roll-2-Roll® Sensor.

With a 12-bit DAC resolution, the smallest change in the analog output that the Roll-2-Roll® Controller can achieve is given by

$$\delta_s = \frac{F_s}{4095}$$

where δ_s denotes the minimum increase in the analog output and F_s represents the full-scale range

in either volts or mA². However, this minimum increment is adjusted according to the sensor(s) being utilized. When a single sensor is employed, the minimum increment in the analog output is calculated as

$$\Delta_p = \frac{4095}{N_p} * \delta_s,$$

where N_p stands for the total number of pixels in the sensor(s). In the case of using two sensors, the total number of pixels equals the sum of the pixels in the two sensors. The output is measured per pixel, thus to convert it into physical units, one must be aware of the conversion from pixel to mm or inches based on the sensor(s) resolution. This scaling factor is expressed as follows:

$$\Delta_o = \frac{\Delta_p}{\gamma},$$

where γ represents the sensor resolution in mm or inches.

 **Note**

The aforementioned scaling assumes that the two sensors employed have identical resolutions as per the standard recommendation. In more complex scenarios, if two sensors with different resolutions are utilized contrary to our recommendation, the following formula should be applied to convert the output into physical units:

$$\Delta_o = \frac{4095}{N_{p1}\gamma_1 + N_{p2}\gamma_2} * \delta_s, \quad (5.1)$$

where N_{p1} and N_{p2} represent the pixel count of sensor 1 and sensor 2, while γ_1 and γ_2 denote the resolution of sensor 1 and sensor 2, respectively.

Hence from the voltage or current measured the position can be obtained from the following formula.

$$W_p = \frac{A_o}{\Delta_o}$$

where, W_p is the web position in mm or inches, A_o is the voltage or current output from SCU5 controller, and Δ_o is the scaling factor.

5.17.1 Analog Mode Selection

Analog output is crucial in cases where the Roll-2-Roll[®] Controller is connected to a legacy system with analog input or to a PLC with an analog input module to provide a more cost-effective solution. For example, older web guide controllers use voltage or current sensors to detect the position of the web. When integrating the Roll-2-Roll[®] Controller into these older systems that depend on either voltage or current sensors, users can choose an appropriate analog mode.

Only one output or analog mode can be chosen from the Roll-2-Roll[®] Controller.

Left Edge

When the analog output is configured to the left, the controller's analog output will represent the position of the left edge. A zero-scale reading is given when the web is outside the sensor's field of

²For a 4 - 20 mA output, considering both bias and gain, the calculation may vary slightly

view. As the web shifts from right to left (as indicated by the arrow in Figure 5.90), the output value for the left edge rises from zero to the full-scale value when the sensor's field of view is completely covered by the left edge of the web.

Info

When the sensor mode is configured for contrast, it is possible to set the analog output mode to the left edge. In such a situation, the output will continue to reflect the contrast position, but the output value will rise as the contrast position shifts from right to left.

Note

- *When two sensors are used (as shown in Figure 5.91), the left edge position value on the analog output will only correspond to the sensor configured to measure the left edge position. The scaling for the analog output will only depend on the respective sensor's resolution and number of pixels.*
- *Even if the width of the web is less than the sensor range (as illustrated in Figure 5.92), the position of the left edge will consistently correspond to the location of the left edge. The width of the web does not impact the value of the left edge that is given as the output.*

Warning

- *To enable the analog output mode on the left edge, it is necessary to configure at least one sensor to be oriented to the left or center orientation as described in Section 5.14.2.*
- *When two sensors are connected and enabled, with one sensor oriented to the left and the other to the right, the analog output can be set to the left, right, or centerline position, as illustrated in Figure 5.91. If either sensor is set to the center orientation, the output becomes more intricate. For detailed guidance on this sophisticated setup, please contact Roll-2-Roll Technologies.*

Right Edge

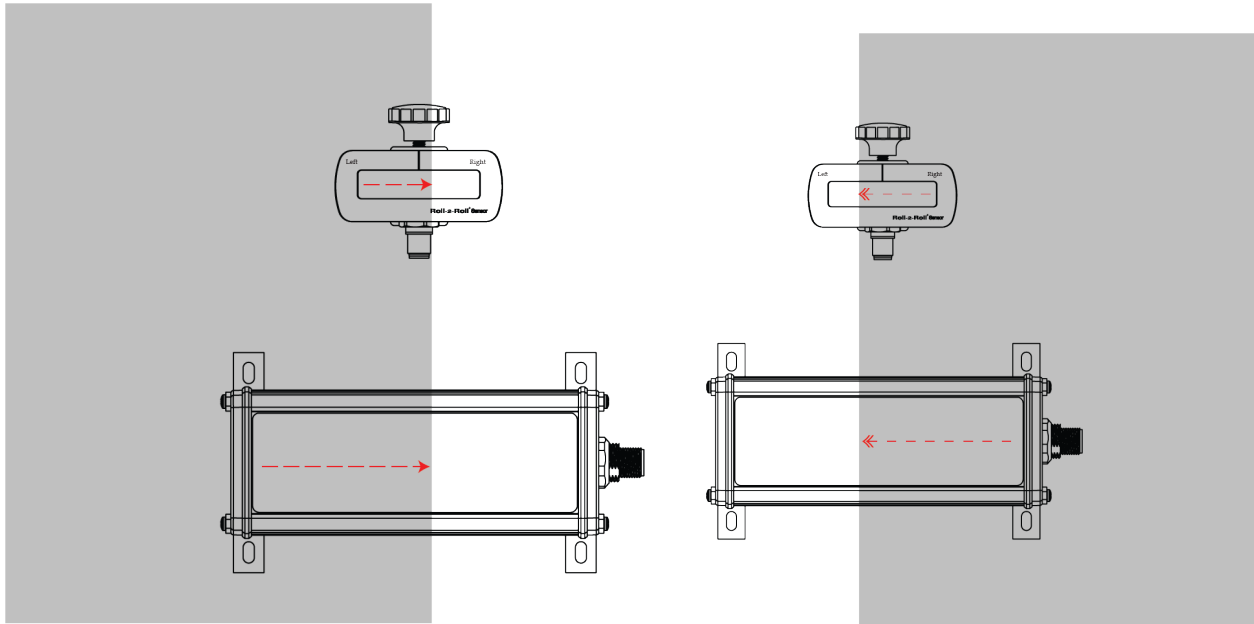
When the analog output is configured to the right edge, the controller's output will indicate the position of the right edge. A zero-scale reading is given when the web is outside the sensor's field of view. As the web shifts from left to right (as shown in Figure 5.89), the output value for the right edge position rises from zero to the maximum scale value when the sensor's field of view is entirely covered by the right edge of the web.

In all other aspects, the right edge analog mode is similar to the left except for the edge position being output.

Even if the width of the web is less than the sensor range (as illustrated in Figure 5.92), the position of the right edge will consistently correspond to the location of the right edge. The width of the web does not impact the value of the left edge that is given as the output.

Warning

- *To enable the analog output mode on the right edge, it is necessary to configure at least one sensor to be oriented to the right or center orientation as described in Section 5.14.2.*
- *When two sensors are connected and enabled, with one sensor oriented to the left and the other*



---> Right Edge Value

<--- Left Edge Value

Figure 5.89: Right edge within the sensor's field of view: output value increases as the web moves from left to right

Figure 5.90: Left edge within the sensor's field of view: output value increases as the web moves from right to left

to the right, the analog output can be set to the left, right, or centerline position, as illustrated in Figure 5.91. If either sensor is set to the center orientation, the output becomes more intricate. For detailed guidance on this sophisticated setup, please contact Roll-2-Roll Technologies.

Centerline Position

The Roll-2-Roll[®] Controller is capable of determining the centerline position of a web using two different methods. One approach involves the use of two sensors, with one sensor detecting the position of the left edge and the other sensor detecting the position of the right edge, as illustrated in Figure 5.91. The calculation for the centerline measurement is detailed in the equation provided in Section 5.1.3. Alternatively, if a single wide sensor covers the entire width of the web, it can be configured to measure the centerline position, as shown in Figure 5.92. In this setup, the centerline position measurement is obtained by averaging the positions of the left and right edges, as explained in Section 5.1.3. This measurement of the centerline position can be presented as an analog output when the analog mode is configured to center.

Note

- If two sensors are connected and enabled, the scaling of the analog output will depend on the pixel count and resolution of each sensor, as indicated by Equation 5.1.
- Enabling two sensors and setting one sensor's orientation to center can complicate the analog output. For detailed assistance with this complex configuration, please reach out to Roll-2-Roll Technologies.

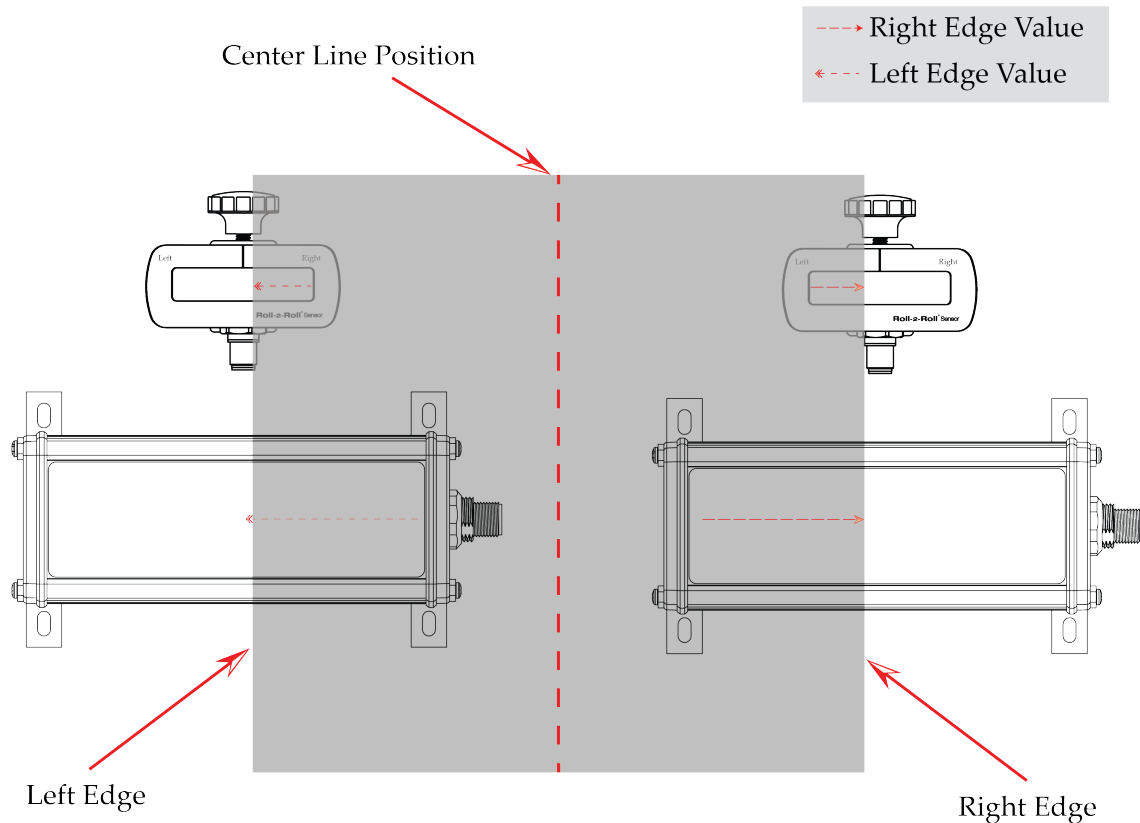


Figure 5.91: Centerline position of the web when using two sensors; one configured to left and the the other right.

Width

The web width measured by the Roll-2-Roll[®] Controller can also be provided as an output by selecting the analog output mode to be width. The two types of web width measured by the controller are absolute web width or error in web width as described in Section 5.6.6.

When opting for the absolute web width setting, the analog output will indicate a value corresponding to the segment of the web captured by the sensor(s). In the case of a single sensor, this value essentially represents the adjusted difference between the positions of the right and left edges, taking into account the sensor's pixel count and resolution. If two sensors are employed, the analog output is the combined measurement of the web segment visible to the left-oriented sensor and the

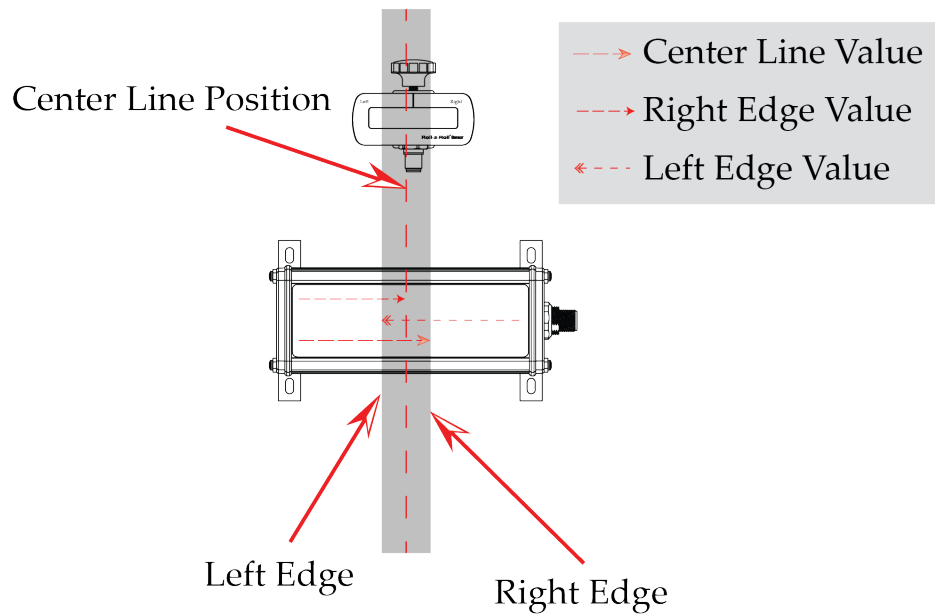


Figure 5.92: Centerline position of the web when using a single sensor that can detect both the left and the right edge.

one visible to the right-oriented sensor, proportionally scaled according to the total pixel count of both sensors and their individual resolutions.

Note

- When employing two sensors, the offset value or the distance between the two sensors is not incorporated into the output when opting for the absolute width output. The analog output will solely mirror the combined portions of the web detected by both sensors. This corresponds to the total of the value of the left edge and the value of the right edge, illustrated in Figure 5.91.
- When employing one sensor, the offset value will be incorporated in the analog output with the absolute width output option.

When opting for the error in web width, the analog output will be the error between the measured web width (including the offset) and the nominal web width set by the user on the operator sensor screen in Section 5.5. The error is calculated as:

$$e_w = M_w - N_w,$$

where e_w represents the deviation in pixel units of the web width, M_w denotes the actual width in pixels, and N_w stands for the expected width in pixels. The pixel resolution for both M_w and N_w are 0.0635 mm or 0.0025 inches per pixel. When the error is zero, the analog output will be at the mid-scale value. In the case of a positive error (where the measured web width is greater than the nominal web width), the analog output value will increase from the mid-scale value. Conversely, for a negative error, the analog output value will decrease from the mid-scale value. Hence the actual analog output is given by

$$A_o = H_s + \frac{4095}{N_{p1} + N_{p2}} * e_w * \delta_s,$$

where A_o is the analog output value, N_{p1} and N_{p2} are the number of pixels in sensor 1 and sensor 2 (both with 0.0635 mm or 0.0025 inch resolution) and H_s is the half-scale analog output value given by $H_s = \frac{F_s}{2}$.

Coverage

Coverage is a different measurement provided by the Roll-2-Roll® Controller. It is determined by the number of pixels within the sensor's field of view that capture the web. This sophisticated metric is used for particular purposes, so it is advisable to reach out to the company for a comprehensive explanation of its use in a specific scenario.

Guide Error

Just like the web width error output mode, the web guide error output mode indicates the discrepancy between the actual web position and the offset value of the guidepoint. This feature is especially beneficial for web guiding applications when integrating the Roll-2-Roll® Controller with an older controller equipped with analog sensors.

While older controllers can function using only the left, right, or centerline position analog output, the web guide error output significantly enhances the capabilities of these controllers. By utilizing the web guide error output, older controllers can incorporate advanced web guiding features such as master/slave operation, guidepoint oscillation, fine and gross guidepoint adjustment, and guidepoint reset functionality from the Roll-2-Roll® Controller. By leveraging the industrial Ethernet capabilities of the Roll-2-Roll® Controller, advanced automation that was previously unattainable with legacy controllers can now be achieved through this output functionality.

When selecting the web guide error mode, the analog signal produced will vary in relation to the error between the guidepoint (or the specified web position) and the current web position (whether it is the edge, centerline, or contrast position). The error is determined as:

$$e_p = GP - W_p,$$

where e_p represents the web position error, GP denotes the guidepoint value in pixels, and W_p stands for the measured web position in pixels. The measured web position could be the left edge, right edge, the centerline position, or the contrast position as identified by one or two sensors. The guidepoint might be a fixed value or a variable value depending on the sophisticated web guiding features like master/slave or guide point oscillation, or remote guidepoint adjustment via industrial ethernet. The error e_p and guidepoint GP are expressed in pixels with a resolution of 0.0635 mm or 0.0025 inch per pixel. Consequently, the analog output can be expressed as

$$A_o = H_s + \frac{4095}{N_p} * e_p,$$

where N_p equals 768.

Info

The scaling of the web guide error is not dependent on the overall pixel count of the sensor(s) employed. This deliberate choice is made to maintain the sensitivity of the analog output towards minor

deviations in web positioning. Additionally, the smallest Roll-2-Roll[®] sensor is regarded as a wide sensor within the industry, offering a measurement range of 48 mm with 768 pixels. Therefore, this scaling approach facilitates seamless integration without necessitating adjustments to the gain of the existing controller.

 **Note**

In addition to choosing the analog mode for web guide error selection, it is essential for the user to configure the Roll-2-Roll[®] Controller to automatic mode (as explained in Section 5.1.8) so that the analog output value can be adjusted according to the web position error equation mentioned earlier.

 **Warning**

Failure to set the Roll-2-Roll[®] Controller to automatic mode will result in the analog output value consistently reflecting the half-scale value.

5.17.2 Analog Voltage and Current Selection

The analog output configuration is adjustable according to the specific use case. The voltage and current levels can be configured by selecting the appropriate options. The voltage choices include ranges of 0 to 5 V, 0 to 10 V, ± 5 V, and ± 10 V. For current output, the available options are 0 to 10 mA, 0 to 20 mA, 0 to 24 mA, and 4 - 24 mA. The table below shows the full-scale range and the half-scale range for the different options.

Analog output based on the range selection					
Voltage Range	F_S in V	H_S in V	Current Range	F_S in mA	H_S in mA
0 - 5 V	5	2.5	0 - 10 mA	10	5
0 - 10 V	10	5	0 - 20 mA	20	10
± 5 V	10	0	0 - 24 mA	24	12
± 10 V	20	0	4 - 24 mA	20	14

 **Note**

Users can choose either the voltage or current output to incorporate into their current system. They have the flexibility to choose different ranges for the voltage and current output. It is important to note that the current and voltage channels are interconnected; a single digital value is transmitted to the digital-to-analog controller, which adjusts the value for the voltage and current channels based on the chosen settings. Users have the freedom to select any combination of voltage and current settings, except when opting for a 0 - 10 mA setting, in which case the voltage output is fixed at 0 - 5 V automatically.

5.17.3 Analog Output Polarity

The analog output's polarity can be modified by selecting the polarity icon. If the button is not activated, the analog output will deliver the value explained in the preceding sections. Conversely, when the polarity button is enabled, the analog output value will be reversed from the full-scale value. So when the polarity is enabled the actual output would be

$$A_{Op} = F_S - A_O,$$

where A_O represents the output as explained in the preceding sections and A_{Op} is actual output with the reversed polarity selection.

5.17.4 Analog Setup Selection

The controller can be configured to set the zero-scale value or the full-scale value by pressing the corresponding button. This feature is beneficial during the calibration of older web guide controllers. Once calibration is complete, the controller can be returned to regular operation by selecting the Normal button.

 **Note**

The controller will switch back to normal operation as soon as the user leaves the analog setup screen.

5.18 Power User: Password Screen

This interface enables advanced users to activate or deactivate password protection for both the power user menu screen and the operator menu screen as described in Section 5.3. Clicking the button will change the password enable/disable setting. When the locked icon is selected, it will turn red indicating the need for a password to access the corresponding screen. When the icon shows an open lock with a green color then no password is necessary to navigate to the respective screen,

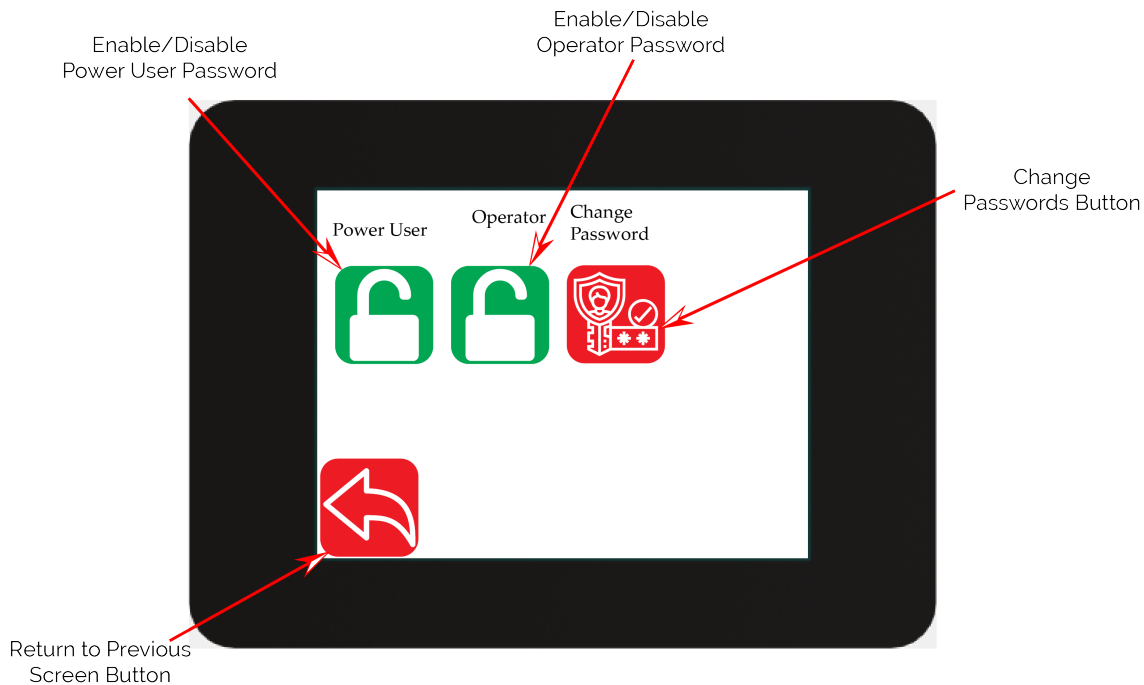


Figure 5.93: Power User: Password Screen

Note

Please contact the factory for the default passwords for the respective screens.

Warning

The default passwords for the screens can be modified. To learn the steps for changing them, it is necessary to get in touch with the factory. After changing the password from the default one, the factory will not be able to assist if the user forgets or misplaces the new password. The sole method to recover is to perform a factory reset, which will restore all controller settings to their original factory defaults.

5.19 Power User: Communication Screen

The screen allows the configuration of the industrial network for the Roll-2-Roll® Controller with the industrial ethernet option. It currently supports industrial ethernet protocols like EtherNet/IP, PROFINET, Modbus/TCP, EtherCAT, and CC-Link IE Field Basic. Users can access status information, network details, and modify specific network parameters on this screen.

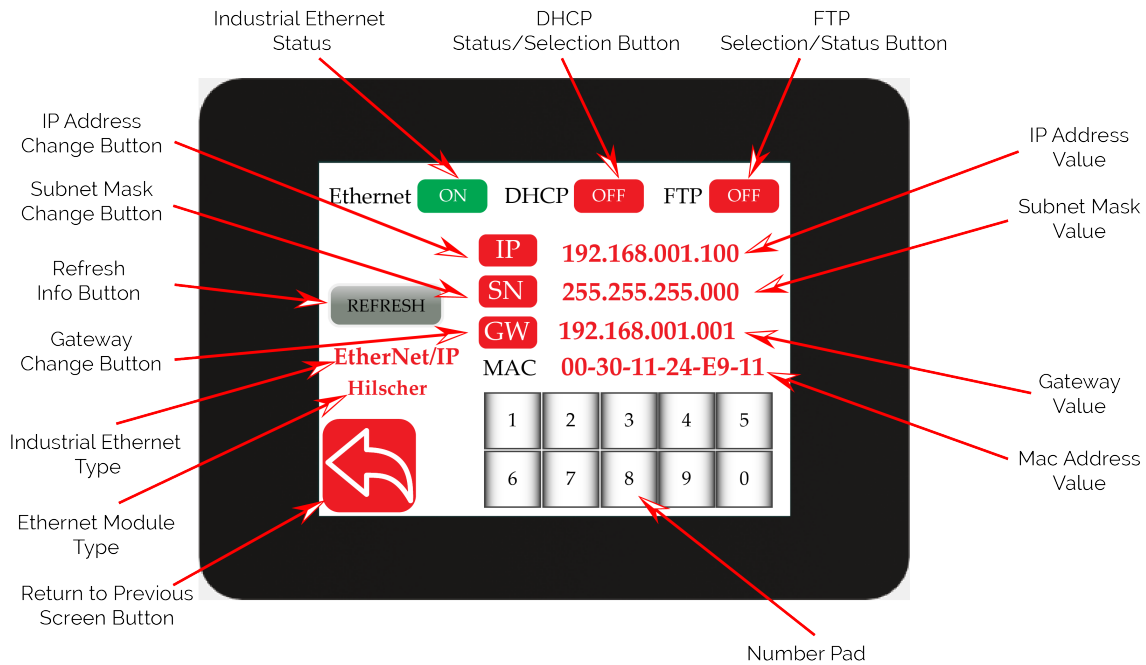


Figure 5.94: Power User: Communication Screen

5.19.1 Ethernet Status

When an ethernet module is installed in the Roll-2-Roll® Controller and activated, the ethernet status indicator will display as ON in green, signifying that the module has been enabled in the controller. If the Ethernet module is deactivated due to the absence of an industrial Ethernet module in the controller, the icon will appear as OFF in red.

If the module is OFF then this screen will have all the values as zero as shown in Figure 5.95

5.19.2 DHCP Status/Selection

When the DHCP feature is enabled, the Roll-2-Roll® controller (client device) will receive its IP address from either a network server or a router. The IP address and other network settings will be allocated dynamically and might be modified following a power cycle if the server or router triggers the adjustment. This is denoted by the green button labeled ON. Conversely, if the DHCP feature is disabled, the controller will utilize static network details (such as the IP address, subnet, and gateway)

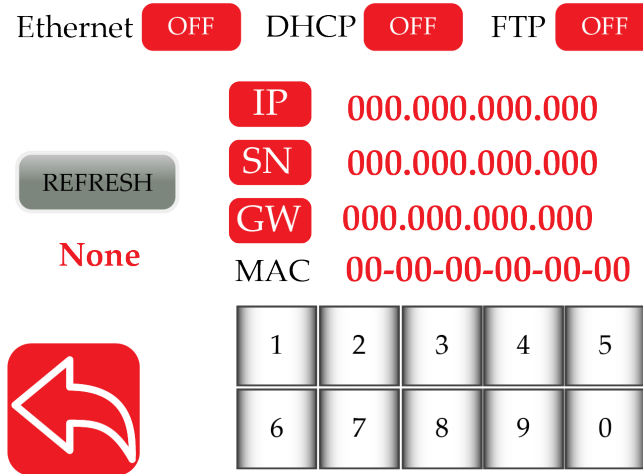


Figure 5.95: Power User: Communication Screen without ethernet module being enabled.

that have been manually configured on the controller or through a static network setup tool specific to the type of ethernet module or network. This condition is denoted by the red button labeled as off.

Users can toggle the DHCP setting by pressing a button. Any alteration in the setting must be confirmed by pressing the "set" button that appears whenever a network parameter is modified.

 **Note**

- The state change from OFF to ON requires a power cycle of the controller. In later versions of the firmware this reset may happen as soon as the SET button is pressed.
- Do not press the refresh button after setting the DHCP OFF. Immediately power cycle the controller. In certain Hilscher modules pressing refresh could set the static IP address back to the factory default value.
- The DHCP can also be set using the IPConfig utility or other network software directly through the network.
- With Hilscher Modules when the DHCP is ON, the IP Address, Subnet Mask, Gateway values on the SCU5 controller might be all zeros. Please use the network software to directly search for the IP address of the SCU5 controller using the mac address.

5.19.3 FTP Status/Selection

FTP access to the web server on the Ethernet module is active when the button is green and labeled ON. On the contrary, if FTP access is deactivated, the button will be red and labeled OFF.

 **Warning**

FTP access is disabled by default, and this advanced feature should only be utilized when the factory specifically instructs it for troubleshooting purposes.

5.19.4 Ethernet Module Type

The Roll-2-Roll[®] Controller utilizes two different vendors, HMS and Hilscher, to facilitate industrial Ethernet communication. These networks within the IC module enable the support of a wide range of industrial Ethernet protocols to meet the requirements of our customers. For users, both modules offer identical functionality in terms of data exchanged with the Roll-2-Roll[®] Controller through the specific industrial Ethernet protocol, depending on the data map provided for the firmware version of the Roll-2-Roll[®] Controller. However, users must be aware of the type of module they are integrating into their PLC and ensure that they have the appropriate support files for the specific module.

5.19.5 Industrial Ethernet Protocol Type

The type of industrial ethernet protocol used is displayed as a string below the refresh button as shown in Figure 5.94. The type of industrial network currently supported are EtherNet/IP, PROFINET, EtherCAT, Modbus/TCP and CC-Link IE Filed Basic.

Note

- If the Roll-2-Roll[®] Controllers do not have the ethernet module enabled, the industrial ethernet protocol type will appear as None, as illustrated in Figure 5.95.
- If the label indicates None despite the industrial ethernet status being ON, it indicates that the ethernet module was not properly initialized during the start-up of the Roll-2-Roll[®] Controller. There could be several underlying reasons for this situation, and for additional help in resolving the problem, it is advisable to contact the factory.

5.19.6 IP Address Value

The valid IP address set in the Roll-2-Roll[®] Controller is displayed as a string of four 8-bit octets as shown in Figure 5.94.

Note

If the IP address is all zeros, there are several possible explanations for this issue:

- The industrial ethernet module may not be enabled, as indicated by its status being OFF, or
- In the case of the Hilscher ethernet module, if DHCP is activated and an external device is responsible for assigning the IP address to the Roll-2-Roll[®] Controller and no IP address has been assigned, or
- In the scenario of a PROFINET industrial network, the network tool has not yet allocated a proper IP address to the Roll-2-Roll[®] Controller, or
- If an EtherCAT industrial network is being utilized, or
- The ethernet module might not have been correctly initialized during the startup of the Roll-2-Roll[®] Controller. There could be various underlying causes for this scenario, and for further assistance in resolving the issue, it is recommended to contact the factory.

5.19.7 Subnet Mask Value

The valid subnet mask value set in the Roll-2-Roll[®] Controller is displayed as a string of four 8-bit octets as shown in Figure 5.94.

Note

If the subnet mask is all zeros, there are several potential explanations for this issue:

- *The industrial ethernet module may not be enabled, as indicated by its status being OFF, or*
- *In the case of the Hilscher ethernet module, if DHCP is activated and an external device is responsible for assigning the subnet to the Roll-2-Roll[®] Controller and no subnet has been assigned, or*
- *In the scenario of a PROFINET industrial network, the network tool has not yet allocated a proper subnet to the Roll-2-Roll[®] Controller, or*
- *If an EtherCAT industrial network is being utilized, or*
- *The ethernet module might not have been correctly initialized during the startup of the Roll-2-Roll[®] Controller. There could be various underlying causes for this scenario, and for further assistance in resolving the issue, it is recommended to contact the factory.*

5.19.8 Gateway Value

The valid gateway address set in the Roll-2-Roll[®] Controller is displayed as a string of four 8-bit octets as shown in Figure 5.94.

Note

If the gateway address is all zeros, there are several potential explanations for this issue:

- *The industrial ethernet module may not be enabled, as indicated by its status being OFF, or*
- *In the case of the Hilscher ethernet module, if DHCP is activated and an external device is responsible for assigning the gateway address to the Roll-2-Roll[®] Controller and no gateway address has been assigned, or*
- *In the scenario of a PROFINET industrial network, the network tool has not yet allocated a proper gateway address to the Roll-2-Roll[®] Controller, or*
- *If an EtherCAT industrial network is being utilized, or*
- *The ethernet module might not have been correctly initialized during the startup of the Roll-2-Roll[®] Controller. There could be various underlying causes for this scenario, and for further assistance in resolving the issue, it is recommended to contact the factory.*

5.19.9 Mac Address

The Ethernet module's hardware MAC address is presented as a string, representing a distinctive and unchangeable value that is for viewing only.

 **Note**

Assuming the Ethernet status is active and the module is correctly initialized, the MAC address should consistently possess a distinct non-zero value.

5.19.10 IP Address Change Button

When DHCP is disabled, the user has the ability to modify the IP address and other network settings on the Roll-2-Roll® Controller for specific types of Ethernet modules and industrial Ethernet protocols.

The process involves the following steps:

1. Initiating the manual IP setting process by pressing the IP address change button, which is indicated by the icon turning green. Simultaneously, the first digit of the IP address value will be hidden, as depicted in Figure 5.96.
2. Using the keypad, the user can input one digit at a time to complete each 8-bit octet value, as illustrated in Figure 5.97. It is essential to use three digits for each octet by adding one or two zeros before the values.
3. Upon entering the last digit, the controller will validate the IP address to ensure that all octets are below 256. If the validation is successful, a set button will be displayed, as shown in Figure 5.98. If the validation fails, the input value for the IP address string will be ignored and the IP address value will display all zeros. This will prompt the user to start over and re-enter the IP address, repeating the first step.
4. Subsequently, by pressing the set button, the user can send the confirmed value to the Ethernet module. This action will cause the IP address button to change color to red and display the refresh button, as depicted in Figure 5.99.
5. When the refresh button is pressed, a request is sent to the Ethernet module to retrieve the current IP address. This step can be used to verify the correct configuration and acceptance of the new IP address on the network, ensuring that there are no conflicts. Nevertheless, the time needed for this refresh may vary depending on the Ethernet network and the module being utilized. Therefore, it is advisable to reboot the Roll-2-Roll® Controller to observe the immediate impact.

 **Note**

- *Providing a valid 8-bit number in each field does not guarantee acceptance by the network. Adherence to network constraints is necessary for these configurations to be applied. The effectiveness of the new settings can only be confirmed by power cycling the device.*
- *The refresh button serves only when the settings are altered by a network device or via the network. Modifying the settings through the Roll-2-Roll® Controller and using the refresh function will not update the settings unless the controller is power cycled.*

5.19.11 Subnet Mask Change Button

Similar to the IP address the subnet mask can be changed. The same steps outlined in Section 5.19.10 can be followed with the exception of using the subnet mask change button to initialize the parameter setting process.

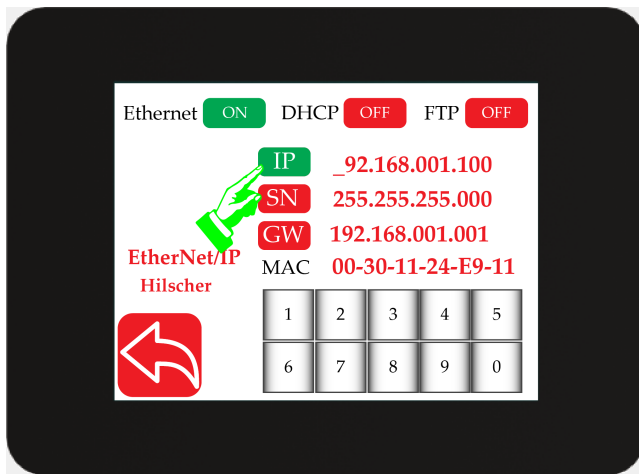


Figure 5.96: Start of IP address change

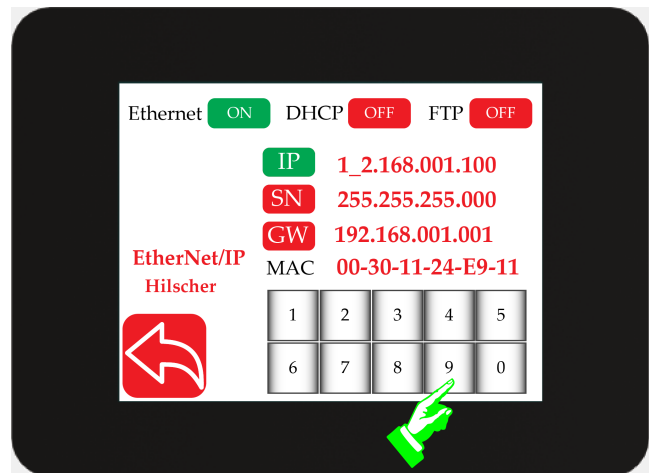


Figure 5.97: IP address value changed by using the numerical keypad

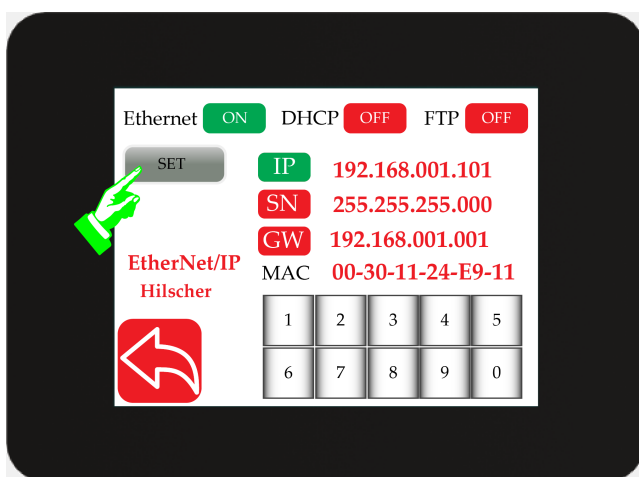


Figure 5.98: With a valid IP address the user is ready to set the new value

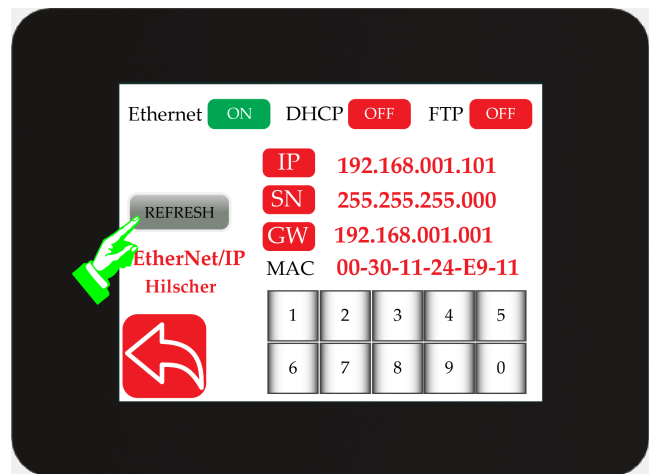


Figure 5.99: Refreshing the network information to verify the new parameters are accepted on the network

5.19.12 Gateway Change Button

Similar to the IP address the gateway can be changed. The same steps outlined in Section 5.19.10 can be followed with the exception of using the subnet mask change button to initialize the parameter setting process.

6. Commissioning

The SCU5 controller can be commissioned after the installation of the Roll-2-Roll[®] Sensors according to the sensor installation recommendations. For instructions on the installation of the sensor for web position detection and web guiding applications, refer to [link](#). For recommendations on sensor installation for inspection applications, see [link](#).

6.1 Sensing and Measurement Applications

In sensing and measurement applications, the SCU5 controller can be connected to any ODC or WPS family of sensors Roll-2-Roll[®] as shown in Figure 6.1. The output from the SCU5 controller is application specific and an appropriate connection to the SCU5 controller can be established based on the controller option and the connection options discussed in Chapter 4.

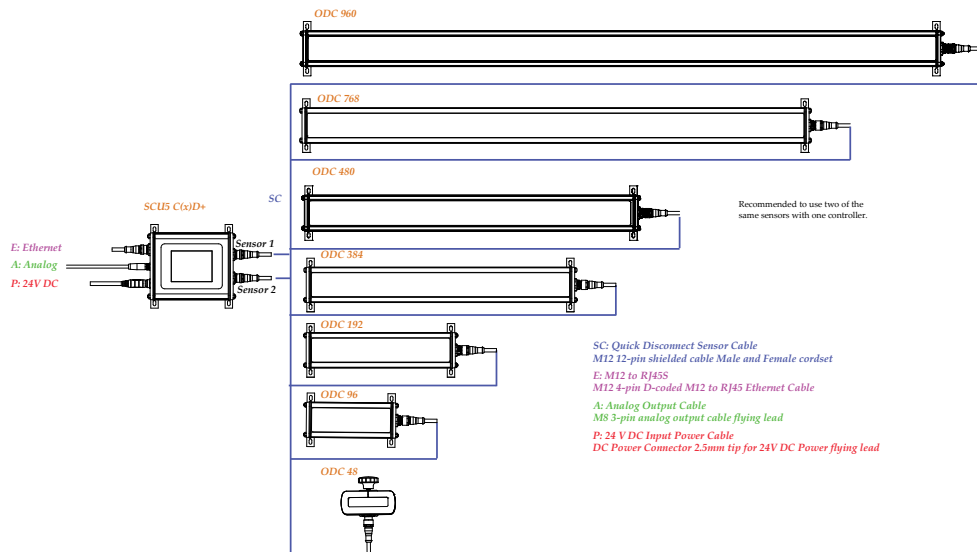


Figure 6.1: Wiring of the SCU5 controller for sensing and measurement applications.

The setup for analog, digital or industrial Ethernet output is tailored to the particular application, as described in Chapter 5. Once the configurations are set up, the user does not need to engage with the controller unless there is a need to during product changeover.

6.2 Web Guiding Applications

In addition to correctly installing the sensor, it is essential to set up the web guide as per the prescribed installation guidelines. The following is a recommended list of documentation available on the Roll-2-Roll Technologies website that users can consult during the installation of the SCU5 controller for web guiding applications.

- [Web Guide Installation Checklist](#)
- [Unwind/Rewind Guide Installation Checklist](#)
- [Web Guide Upgrade Kit Installation Checklist](#)
- [Installation of Displacement Guide](#)
- [Installation of Steering Guide](#)
- [Master/Slave Web Guiding System Installation](#)

Below are some illustrative examples of the SCU5 controller wiring for web guiding applications, depicted in Figures 6.2, 6.3, 6.4.

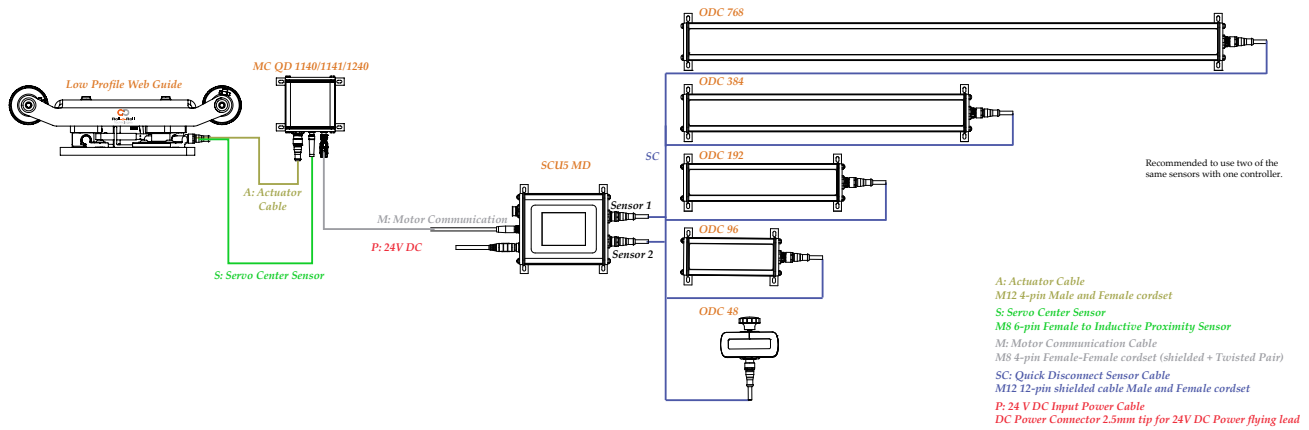


Figure 6.2: Wiring example with a displacement guide.

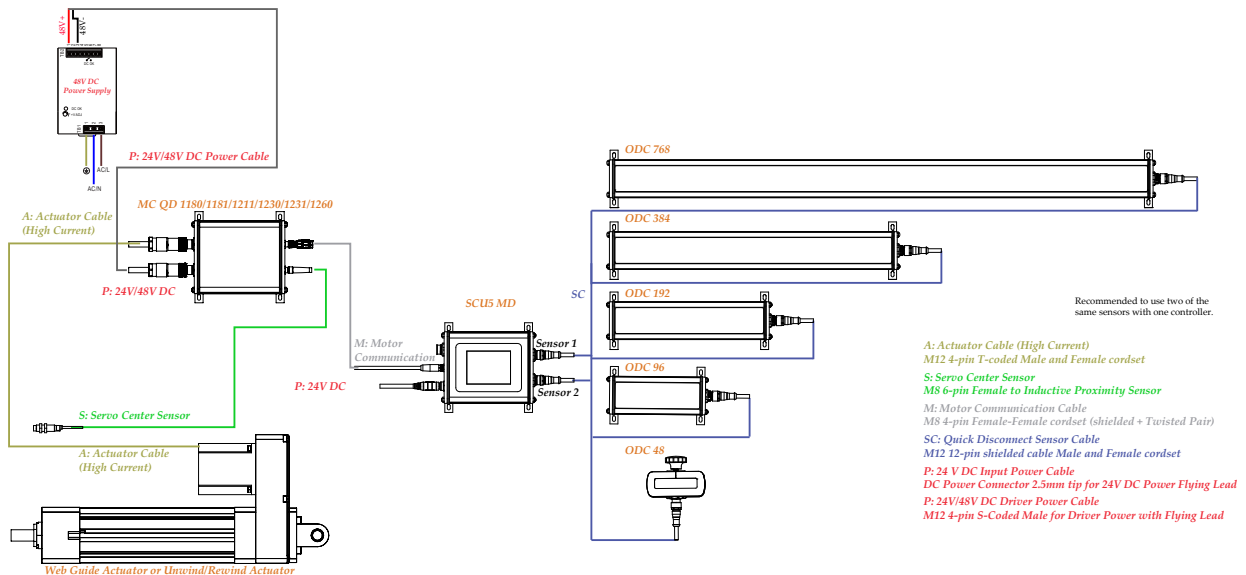


Figure 6.3: Wiring example with a unwind/rewind actuator.

To ensure optimum performance, a properly installed web guide requires the correct threading of the web over the guide rollers and initial positioning of the sensor based on the desired position of the

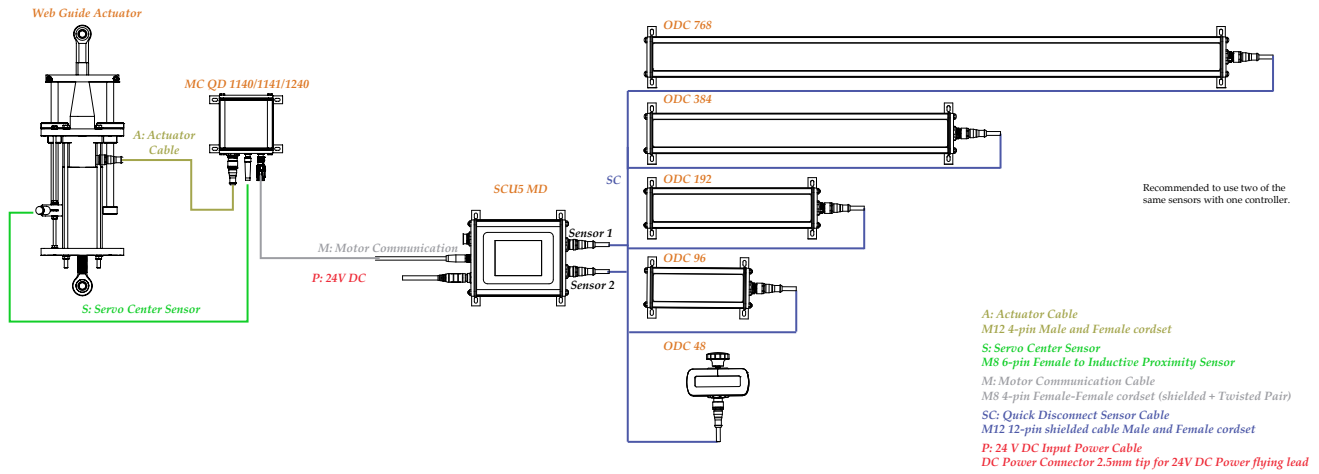


Figure 6.4: Wiring example with web guide upgrade actuator.

web. Once the material is threaded on the guide rollers and the sensor has been properly positioned, the operator simply needs to press the automatic operation icon on the operator interface. Please refer to the respective Roll-2-Roll[®] Sensor and Roll-2-Roll[®] Web Guide manual for proper installation of the web guiding system.

7. Technical Support and Service

7.1 Contact information

Roll-2-Roll Technologies is dedicated to providing exceptional service and support to its customers. Please feel free to contact us for any technical support, installation support, and service requirements.

Roll-2-Roll Technologies LLC
1110 S Innovation Way Dr
Stillwater, OK 74074
Website: <https://r2r.tech>
Technical Support Phone: +1 (888) 290-3215 - ext 3
General Support Phone: +1 (888) 290-3125 - ext 1
Technical Support Email: engineering@r2r.tech
General Support Email: support@r2r.tech

7.2 Return shipping instructions

Please contact us to obtain a return merchandise authorization (RMA) number before sending back the item. Items returned without an RMA will slow down the service and support process and may result in extra processing fees. You can access an online RMA form at <https://r2r.tech/rma>. To complete the RMA, it is crucial to include the product label with the serial number, firmware version, and sales order number. When returning the product, please adhere to the instructions provided in the RMA form to guarantee efficient and timely service.

Firmware Revision History

FIRMWARE	DOCUMENT DATE	VERSION DESCRIPTION
1.0	Jan 2015	Initial version, single sensor
1.1	Aug 2015	Firmware update for SCU V3, automatic sensor state detection
1.2	Nov 2015	Firmware update for SCU V4 Rev B. Modified sensor algorithm to increase precision and accuracy.
1.3	Dec 2015	Two sensor option with automatic pixel detection
1.4	Mar 2016	Background suppression algorithm
1.5	Apr 2016	Analog output
2.1a	Aug 2016	Firmware update for SCU V4 Rev D
2.2b	Dec 2016	Ethernet/IP implicit messaging, edge detection algorithm updates
2.4a	Jun 2017	Changes to guide point adjustment and Ethernet/IP registers
2.5	Apr 2018	Minor bug fixes, enabled password protected screen
2.6	Nov 2018	Provided more access to internal settings of the controller for power users.
3.3	Dec 2018	Updated functionality to version 3 algorithm.
3.3c	Jan 2019	Updated functionality to include minimum contrast setting.
3.3d	Jun 2019	Added functionality for both static and dynamic thresholding.
3.4	Jul 2019	Significant update with added functionality for power user access and for built in width measurement application.
3.4a	Aug 2019	Added the ability to view and change the ethernet network settings from the SCU5 controller communication screen.
3.4b	Mar 2020	Improvements to edge detection algorithms and improved processing speed.

3.5b	Oct 2020	Added support for 2x WPS 440 with digital I/O
3.6a	Aug 2021	Added support for ODC 48, 96, 192, 384
3.6b	Nov 2021	Added support for Hilscher module
3.6c	Nov 2021	Added support for ODC 768
3.6d	Dec 2021	Added actuator position screen to show the actuator position
3.6d	Mar 2022	Added support for ODC 480
v3.6e	May 2022	Added ability to reset servo center position electronically (with and without a physical servo center sensor)
3.6f	Jun 2022	Added support for MC QD 12xx drivers
v3.6g	Oct 2022	Updated edge detection algorithm to count up to 64 threads or 128 edges
v3.6i	Jan 2023	Added Master/Slave and Oscillation functionality to master branch as standard for all SCU5s
v3.6i	Feb 2023	Added support for ODC 960
v3.6l	Mar 2023	Added flag detection algorithm to master branch as standard for all SCU5s
v3.6m	Dec 2023	Added functionality to reset servo center position only when the power user access is not password protected
v3.6n	Feb 2024	Added support for zooming to a smaller window in contrast mode, guide error for analog output



Roll-2-Roll
Technologies

**Simple to Use Products for Challenging
Problems**